



Resolute

# ASX Announcement

14 October 2020

## Tabakoroni Underground Potential

**Underground Resource grows to 1 million ounces at 4.4g/t gold**  
**Exploration success continues with further excellent results**  
**Study progress confirms potential future underground mine**  
**Updated Syama Life-of-Mine Plan expected**

### Highlights

- Tabakoroni Underground Mineral Resource Estimate updated to 7.4 million tonnes at 4.4 grams per tonne for 1.04 million ounces of gold
- Exploration program continuing at Tabakoroni with further exceptional assay results from recent drilling yet to be included in the updated Mineral Resource Estimate
- Recent deep intersections beyond updated resource outline confirm mineralisation is continuous at depth.
- Results from new drilling underneath the updated resource at **Tabakoroni Deeps** include:
  - TADD780      **7m @ 10.5g/t Au** from 405m;
  - TADD781      **9m @ 5.2g/t Au** from 443m; and
  - TADD773      **5m @ 116.3g/t Au** from 222m.
- Results from shallow oxide reverse circulation drilling at new zones of surface gold mineralisation at **Tabakoroni Porphyry Splay** include:
  - TARC767      **8m @ 5.0g/t Au** from 61m;
  - TARC772      **7m @ 6.7g/t Au** from 33m;
  - TARC791      **4m @ 52.5g/t Au** from 49m; and
  - TARC805      **10m @ 4.2g/t Au** from 104.
- Pre-Feasibility Study completed during September 2020 quarter demonstrates potential for future underground mine at Tabakoroni using existing Syama processing infrastructure. Key outputs include:
  - Tabakoroni Underground production of ~80,000 ounces of gold annually;
  - All-In Sustaining Cost of US\$974 per ounce over an initial four-year mine life based on current Mineral Resource Estimate; and
  - Start-up capital requirement of US\$86 million with total project capital of US\$118 million.
- Tabakoroni underground operation expected to use modified Syama oxide processing infrastructure and thus planned to commence following completion of Syama oxide operations.
- Study outcomes and Syama oxide exploration progress to enable updated Syama Life-of-Mine Plan to be completed and published during the current quarter.



Resolute

## ASX Announcement

Resolute Mining Limited (ASX/LSE: RSG) (Resolute or the Company) is pleased to announce an updated Mineral Resource Estimate and ongoing exploration success at Tabakoroni which has enabled the completion of a Pre-Feasibility Study (PFS or the Study) to assess the potential for a new underground gold mine at Tabakoroni to augment gold production from the Company's Syama Gold Mine in Mali (Syama).

The Tabakoroni Mineral Resource has been upgraded to 7.4 million tonnes (Mt) at 4.4 grams per tonne (g/t) gold (Au) at a 1.5g/t Au cut off for a total of 1.04 million ounces (Moz), an increase of 22% over the previous estimate (see ASX Announcement dated 29 April 2019). The Study has established a mining schedule, consisting of Indicated and Inferred Resources, of 2.4Mt at 4.9g/t containing 387koz (see Note 1 below). Gold production is expected to average approximately 80,000oz per annum over an initial four-year mine life. The All-In Sustaining Cost (AISC) is calculated to be US\$974/oz. The Tabakoroni underground deposit remains open both along strike and at depth and ongoing exploration success is expected to expand Mineral Resources and extend mine life.

Managing Director and CEO, Mr John Welborn, welcomed the Study, which provides support for the ambition of establishing underground operations at Tabakoroni which will enable total production from Syama to be sustained at approximately 250koz per annum going forward:

"Tabakoroni has been a highly successful Syama satellite open pit oxide mining operation for Resolute, producing approximately 400,000 ounces of gold over the past three years. We expect our ongoing exploration success and feasibility studies will confirm a future underground operation at Tabakoroni."

"Exploration and evaluation of the Tabakoroni underground mine potential will continue during the remainder of 2020 and into 2021. The timeline on development is supported by our contemporaneous exploration efforts to define further surface oxide mineralisation. We now have more than 500,000 ounces of oxide resources from in ground satellite deposits and oxide ore stockpiles. Our immediate ambition is to use this oxide material, and further satellite oxide resource targets we are exploring, to maintain our Syama oxide production going forward at approximately 80,000 ounces per annum."

"The Tabakoroni underground Study provides confidence that we will be able to transition current Syama Oxide gold production, based on Syama satellite open pit mining, to similar annual levels of production based on a Tabakoroni underground operation. Further detail on our plans for Syama will be published in an updated Syama Life-of-Mine plan which will be completed during the current quarter."



**Figure 1: Tabakoroni open pit operation and existing surface infrastructure**

<sup>1</sup> Note that the Mining Inventory of 2.4Mt at 4.9g/t contains both Indicated (54%) and Inferred (46%) Mineral Resources. 46% of the production target ounces referred to in this document is based on Inferred Mineral Resources. There is a lower level of geological confidence associated with Inferred Mineral Resources and there is no certainty that further exploration work will result in the determination of indicated mineral resources or that the production target itself will be realised.





Figure 2: Oxide processing plant at Syama, to be repurposed for Tabakoroni sulphide processing

## Updated Tabakoroni Underground Mineral Resource Estimate

### Geology and Mineralisation

Gold mineralisation at Tabakoroni is hosted within the 5 to 25m thick Tabakoroni Main Shear Zone (TMSZ), a brittle-ductile shear zone developed in carbonaceous shale and siltstone rocks and localised along the eastern margin of Syama Formation basalt-dolerite flows and interflow sediments. The TMSZ gold mineralisation is associated with pyritic and carbonaceous fault gouge. Adjacent sandstone and siliceous siltstone display stockwork quartz-carbonate veins with pyrite disseminated throughout. Stylolitic quartz reefs are developed along the length of the TMSZ.

Drilling to date has identified high grade gold mineralisation over a strike length of 1.8km with better gold grades seen where the shear intersects the basalt sediment contact. North of the Namakan pit the basalt is absent in the hanging wall and better grades are associated with felsic porphyry intrusives within the TMSZ.

### Resource Estimation and Classification

Resolute published the maiden underground resource at Tabakoroni on 29 April 2019 comprising 5.2Mt @ 5.1g/t Au for 850,000oz. Since that time diamond drilling has continued uninterrupted with the focus on infill and extensional drilling to increase the confidence in the geological model and to improve continuity in the mineralisation. Interim results from this drilling was reported on 12 December 2019 with numerous high-grade intersections confirming the width and grade of the underground mineralisation. The drilling program was completed to a nominal drill density of 50m and the resource was subsequently re-estimated in the second quarter of 2020.

The underground resource at Tabakoroni was updated to underpin the Study. The resource was estimated by wireframe constrained Ordinary Kriged (OK) methodology, as used in the previous estimate in April 2019.

Tabakoroni Underground Resource			
Category	Tonnes (000)s	Gold (g/t)	Ounces (000s)
Measured	410	3.73	50
Indicated	2,940	4.86	460
Inferred	4,070	4.04	530
<b>Total</b>	<b>7,420</b>	<b>4.35</b>	<b>1,040</b>

Table 1: Tabakoroni Underground Mineral Resources



Mineralisation wireframes for underground were created with a cut-off grade of 1.5 g/t Au with a minimum downhole thickness of 2m. Five domains have been identified at Tabakoroni. The main domain is the TMSZ which is a steeply dipping shear mineralised over 1.8km of strike. A second domain was created for the parallel lodes adjacent to the TMSZ, and there are a number of shear-parallel smaller lodes. Another domain was created for the shallow westerly-dipping lodes in the southern portion of the deposit. These lodes are dipping at 45° and appear to overprint the TMSZ. A further domain created was the steeply dipping mineralisation in the north-eastern portion of the deposit, which strikes at 20° to the northeast. The final domain is referred to as Namakan Deeps which are shallow westerly-dipping lodes in the central portion of the deposit. These lodes appear to be veins with significant presence of arsenopyrite.

Gold, sulphide sulphur, organic carbon and arsenic was estimated into a three-dimensional block model using OK methodology with dynamic anisotropy to account for the undulating nature of main shear zone.

Top cutting was required to reduce the influence of outlier values. Variograms were generated for the mineralised 1 metre composites. Optiro carried out kriging neighbourhood analysis based upon the gold variograms to optimise the estimation parameters, and these parameters were used for ordinary kriging into the 5m x 10m x 5m parent cells.

Density was assigned based on weathering codes; 2,190 measurements were taken from diamond hole samples. These measurements suggested a density of 2.72g/m<sup>3</sup> for the fresh, 2.38g/m<sup>3</sup> for the transitional material and 2.12g/m<sup>3</sup> for the oxide material.

The estimation was validated and then classified as Measured, Indicated and Inferred in accordance with the JORC Code (2012) reporting guidelines. The default classification for the mineralisation is an Inferred Mineral Resource. Measured Mineral Resources are defined by contiguous zones where the nominal drillhole density is 12.5m by 12.5m, while an Indicated Mineral Resource has been defined by zones where the nominal drillhole density is around 25m by 25m. The resource has been depleted for mining as of 31 March 2020.

## Study Outcomes

The Study incorporates the updated underground Mineral Resource and multiple technical studies. The Study estimates include all capital and operating expenditure and royalties over the proposed Life-of-Mine plan (LOM). Ore mined comprises Indicated and Inferred Mineral Resources (See Note 1). Project capital is estimated to be US\$118 million (m) with estimated start-up capital of US\$86m. Project capital includes US\$20.4m for conversion of the current Syama Oxide processing plant to also process sulphide material (retains the ability to process oxide material in the event of further exploration success) and US\$12.6m for a new paste plant, power and underground infrastructure for the underground operation at the Tabakoroni site. All existing open pit infrastructure will be repurposed for the underground. Underground mining and ore haulage to the processing plant at Syama is planned to be undertaken by a contractor similar to current practice at Syama and Tabakoroni open pits, further diminishing the initial capital requirement and ensuring prompt access to ore.

Key Study outcomes are summarised below:

	Units	2020 Study
<b>Underground development</b>		
Ore development	m	7,836
Waste development	m	14,492
Vertical development	m	1,498
Total development	m	23,826
<b>Ore production</b>		
Development ore	kt	403
Stoping ore	kt	2,056
Total ore	kt	2,459
Metal grade (ROM)	g/t	4.9





	Units	2020 Study
Metal contained (ROM)	koz	387
<b>Metal recovery</b>		
Processing recovery	%	83
Metal (recovered)	koz	321
<b>Operating unit costs</b>		
Underground Mining (excl. pre-production, including haulage to process plant)	US\$/t	72.2
Processing	US\$/t	18.3
General and Admin	US\$/t	11.6
Royalty, refining and off-site costs	US\$/t	11.8
<b>Costs</b>		
Sustaining capital	US\$M	32
Operating cost (excl. pre-production costs)	US\$M	281
<b>AISC</b>	<b>US\$/oz</b>	<b>\$974</b>
<b>Mine life (incl. pre-production)</b>	<b>years</b>	<b>5.2</b>

Table 2: Tabakoroni Underground key study outcomes

## Project Summary

### Location

Tabakoroni is located within the Finkolo Permit, 35km south of the Syama Gold Mine (Syama) processing plant in southern Mali (refer to Figure 3). Tabakoroni is connected to Syama via a purpose-built all-weather unsealed haul road.

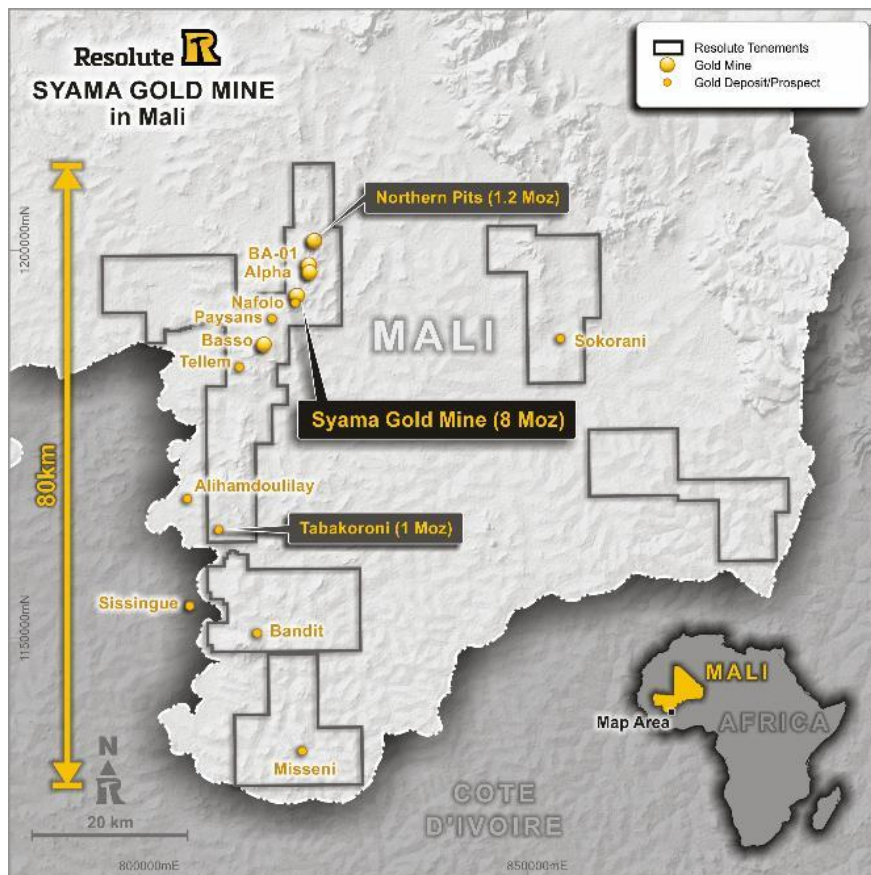

Figure 3: Tabakoroni project location map



## History

Resolute completed the acquisition of the Finkolo Permit in April 2018 (see ASX Announcement dated 25 May 2018). Resolute's initial exploration focus at Tabakoroni was on identifying oxide resources. Open pit operations commenced at Tabakoroni in late 2018 with high grade oxide and transitional material currently being mined and processed through the 1.5Mtpa Syama oxide circuit. To date open pit operations at Tabakoroni have delivered 3.8 million tonnes of ore at 2.4g/t containing 288koz of recovered gold.

Resolute published a maiden underground resource for Tabakoroni on 29 April 2018. An internal conceptual study was completed in 2019 to identify areas of interest for further infill drilling, as well as extensional drilling. Drilling continued during 2019 and 2020, resulting in an updated underground resource model to support the Study.

## Scope of the Study

The objectives of the Study included the following:

- Deliver PFS in September 2020 on Tabakoroni Underground potential
- Replace oxide gold production (~80 koz Au per year)
- Confirm a viable mine plan (mining method, design and schedule)
- Confirm an initial mine life (~ 5 years inventory)
- Confirm a reliable processing option (flow sheet, design and recovery)
- Consider the impact on all stakeholders (environmental, social, security, etc)

## Study Contributors

The mining, processing and cost estimation components were performed by Resolute, with contributions from the industry experts shown in Table 3.

Company	Study Input
Optiro Pty Ltd (Optiro)	Resource Estimation
AMC Consultants Pty Ltd (AMC)	Geotechnical logging and modelling, ground support, dilution
Solid Geology Pty Ltd	Structural and Lithological interpretation and modelling
Outotec	Backfill options analysis
Piteau	Hydrogeology and water management
Digby Wells Environmental (Digby Wells)	Environmental and Social Impact Assessment
Osprey International	Security analysis
Practara	Economic Modelling
Outotec	Processing options, sulphide roast testing to produce calcine
ALS Geochemistry	Calcine leach and recovery test work, ongoing variability testing

**Table 3: Study Contributors**

## Key Study Elements

### Mining

The Study identified long hole open stoping (LHOS) mining methods as the most suitable to the style of mineralisation and geotechnical conditions. A trade-off study of various underground methods was undertaken, and the selected mining methods were:

- The main mining method will be LHOS with cemented paste backfill. This method was applied to the TMSZ in the Northern Zone, and upper parts of the Namakan Zone where the mineralisation is 4m to 15m wide and near vertical. Preliminary test work conducted on Syama tailings and the highly weathered Tabakoroni open pit oxide waste indicated that both sources can successfully be used to make a cemented paste fill.





Resolute

## ASX Announcement

- In the western hangingwall of the Namakan Zone narrower (2m to 6m wide) and shallower dipping ( $45^\circ$  to  $60^\circ$ ) mineralisation parallel to the TMSZ are located in good ground conditions and lends itself to open stoping with pillars without fill.

The mine design covers a strike length of over 1km, located primarily below the Tabakoroni Namakan and North pits as shown in Figure 4. New surface infrastructure requirements are kept to the minimum by reutilising the current open pit infrastructure and positioning the portal in the Namakan Pit to avoid extensive box cutting through the weathered overburden layer. New infrastructure is limited to a new power plant for the underground (obsolete generators will be relocated from Syama as part of the Syama Power Plant upgrade project), a paste plant, a surface explosive magazine and some minor infrastructure modifications and additions to the existing open pit infrastructure as required for underground mining.

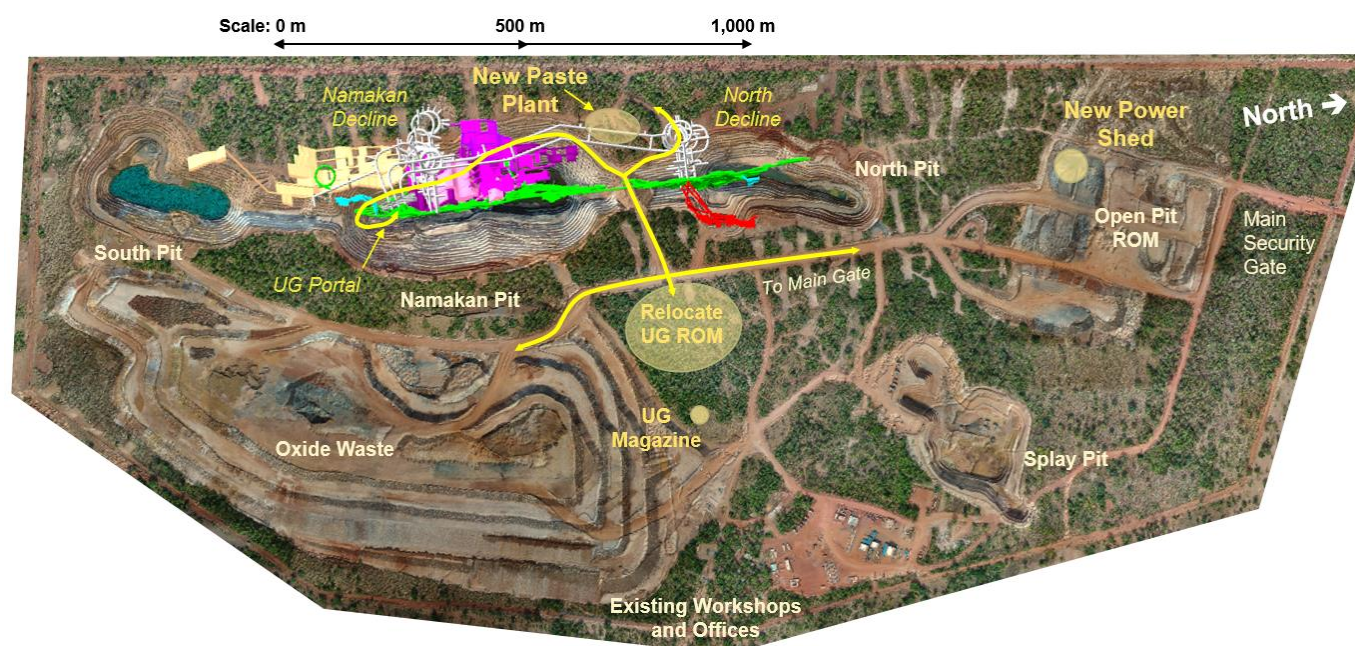

**Figure 4: Tabakoroni surface infrastructure general arrangement**

Primary stoping focuses on the ore located between 60,100mN and 61,000mN (local grid). Due to the strike length of the design and two higher grade zones naturally forming below the North Pit (Northern Zone) and Namakan Pit (Namakan Zone) respectively, two declines will be developed. The Northern Decline serves a strike length of approximately 300m of ore and the Namakan Decline approximately 600m strike length of ore. The planned mine design is shown in long-section in Figure 5.

Development dimensions have been designed to suit the selected equipment and expected geotechnical conditions. Declines will be 5.5m W x 5.8m H, positioned in the more competent basalt rock to the west and suitable in size for 55t to 63t trucks. Lateral development requiring truck access will have dimensions of 5.5m W x 5.5m H, and 4.5m W x 4.5m H in the ore drives. A 20m vertical level spacing was selected to ensure good ground control during drilling and blasting, especially in the shallower dipping stopes. Drill rigs capable of drilling 89mm diameter blastholes were selected.

Mine design was performed using Deswik Mineable Shape Optimiser (MSO) at a cut-off grade of 3.0 g/t Au. Geotechnical modelling identified ground conditions ranging from poor to good, for both hangingwall and footwall conditions. Modelled stope dilution of 0.5m (good) to 2.0m (poor) were included into the MSO analysis for each domain and separated for hangingwall and footwall based on modelled conditions. Maximum stope lengths were estimated at 10m to 50 m based on ground conditions. However, scheduling was done on maximum stope lengths of 20m until final grade control drilling can confirm localised ground conditions. Isolated stopes and sub-economic levels were removed, and sub-economic internal stopes were left insitu as regional support pillars. Declines were



Resolute

# ASX Announcement

positioned to provide early ore access, while taking potential future expansion into account as the mineralisation is still open both along strike and at depth.

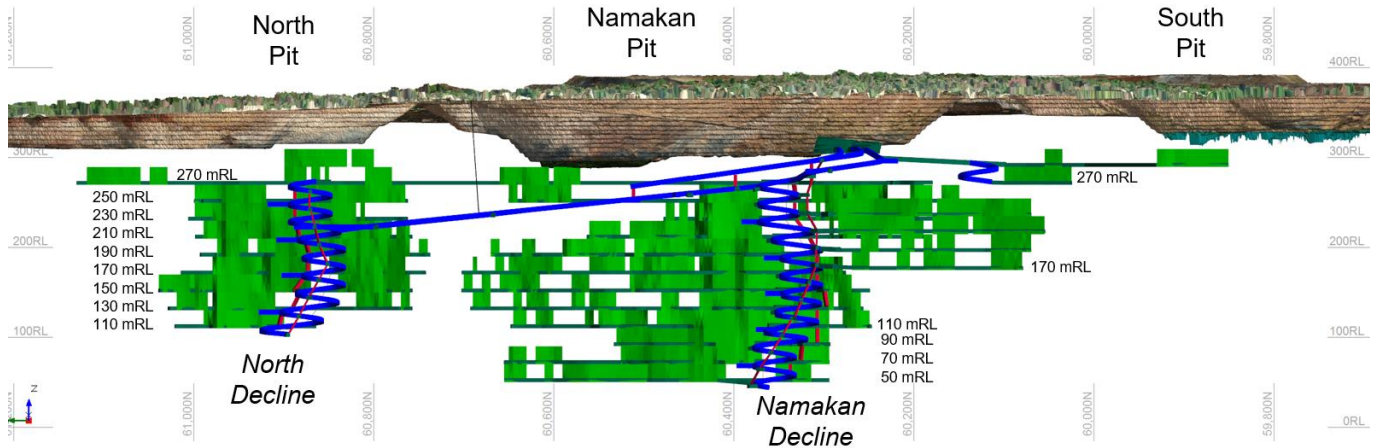

**Figure 5: Tabakoroni long section of mine design (looking east)**

A detailed Deswik schedule was constructed to schedule development, production drilling, stoping and backfill. The following schedule priorities and sequence were then applied:

- Establish portal in Namakan Open Pit
- Develop decline access and primary ventilation on 270 mRL
- Develop the connection decline to connect North Zone and Namakan Zone, and connect paste fill lines and primary services networks from surface
- Develop Namakan Decline and North Decline independently. Some early opportunistic stoping is possible below South Pit
- Develop ore drives on each level to economic limits and retreat stoping back to level access in a top-down sequence
- Paste fill each stope prior to mining the next stope. Where mining conditions allow, mine stopes as open stopes without fill
- Figure 7 and Table 4 show a steady state production rate of 650ktpa to 750ktpa (160kt to 180kt per quarter).

Figures 6 to 8 illustrate the development schedule over the LOM, the anticipated ore production schedule and gold mined and recovered. It should be noted that Year 6 Quarter 1 in the production schedule consists of only one month's production and should not be viewed as a full quarter's production. Further mine plan optimisation programs and exploration success could alter the mine plan and could provide some investment upside.



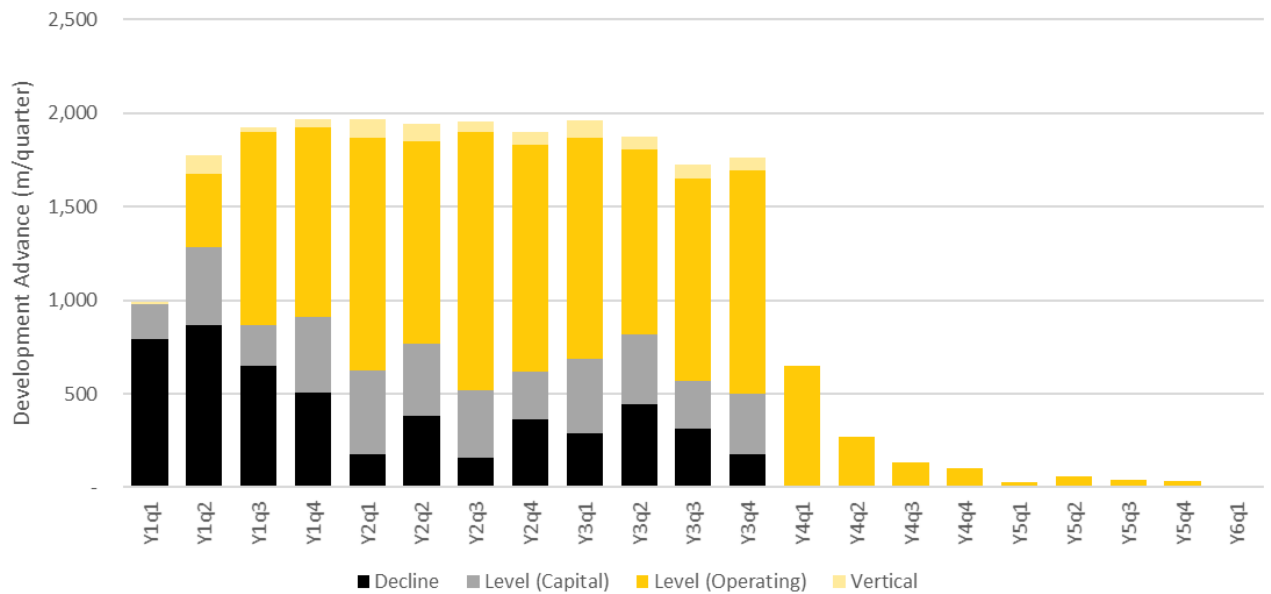

Figure 6: Development Schedule

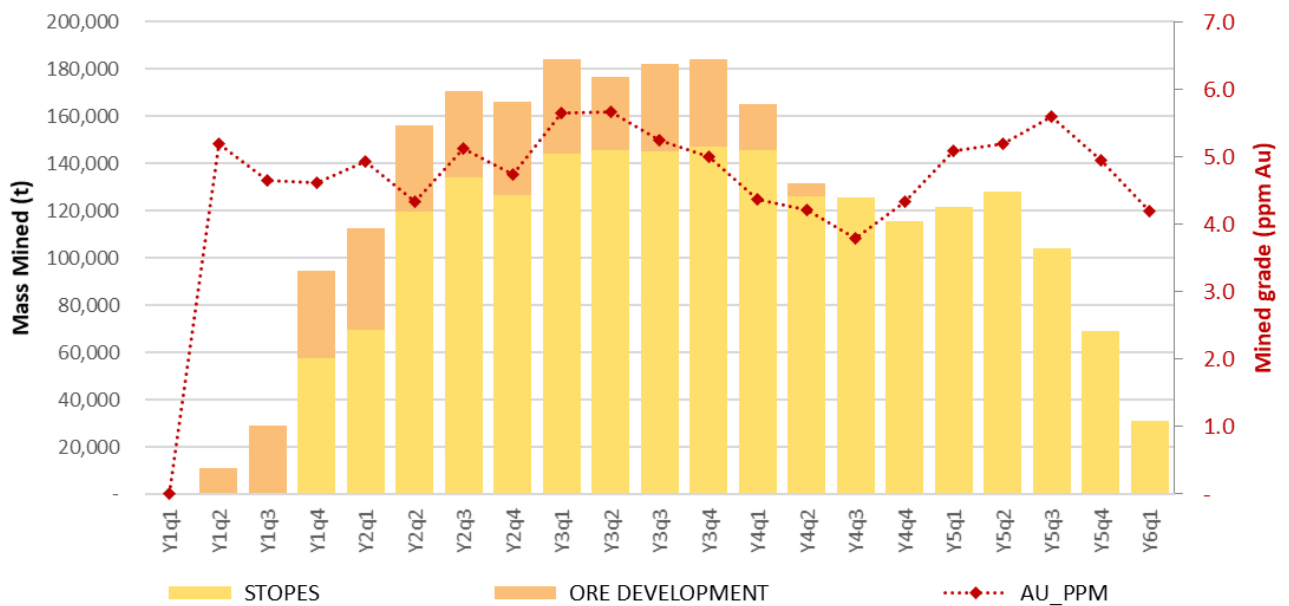

Figure 7: Ore Production Schedule

<sup>1</sup> Note that the Mining Inventory of 2.4Mt at 4.9g/t contains both Indicated (54%) and Inferred (46%) Mineral Resources. 46% of the production target ounces referred to in this document is based on Inferred Mineral Resources. There is a low level of geological confidence associated with Inferred Mineral Resources and there is no certainty that further exploration work will result in the determination of indicated mineral resources or that the production target itself will be realised.



Resolute

# ASX Announcement

Physicals	Units	Y1q1	Y1q2	Y1q3	Y1q4	Y2q1	Y2q2	Y2q3	Y2q4	Y3q1	Y3q2	Y3q3	Y3q4	Y4q1	Y4q2	Y4q3	Y4q4	Y5q1	Y5q2	Y5q3	Y5q4	Y6q1	Total
<b>LATERAL DEVELOPMENT</b>																							
Decline	m	854	869	651	509	177	383	156	360	287	442	313	174	-	-	-	-	-	-	-	-	-	5,175
Level	m	186	417	216	403	446	384	360	257	403	372	257	326	-	-	-	-	-	-	-	-	-	4,028
<b>Capital - Total</b>	<b>m</b>	<b>1,040</b>	<b>1,285</b>	<b>867</b>	<b>912</b>	<b>624</b>	<b>767</b>	<b>517</b>	<b>617</b>	<b>690</b>	<b>814</b>	<b>570</b>	<b>500</b>	-	-	-	-	-	-	-	-	-	<b>9,203</b>
Operating - Total	m	-	393	1,034	1,015	1,243	1,083	1,380	1,213	1,178	991	1,082	1,195	647	271	135	100	25	60	40	35	5	13,124
<b>Total</b>	<b>m</b>	<b>1,040</b>	<b>1,678</b>	<b>1,901</b>	<b>1,927</b>	<b>1,867</b>	<b>1,850</b>	<b>1,897</b>	<b>1,830</b>	<b>1,868</b>	<b>1,805</b>	<b>1,652</b>	<b>1,694</b>	<b>647</b>	<b>271</b>	<b>135</b>	<b>100</b>	<b>25</b>	<b>60</b>	<b>40</b>	<b>35</b>	<b>5</b>	<b>22,328</b>
Lateral Ore	m	-	205	559	712	819	718	714	771	788	610	716	729	383	112	-	-	-	-	-	-	-	7,836
Lateral Waste	m	1,040	1,473	1,342	1,215	1,048	1,132	1,184	1,058	1,080	1,195	936	965	264	159	135	100	25	60	40	35	5	14,492
<b>Lateral Total</b>	<b>m</b>	<b>1,040</b>	<b>1,678</b>	<b>1,901</b>	<b>1,927</b>	<b>1,867</b>	<b>1,850</b>	<b>1,897</b>	<b>1,830</b>	<b>1,868</b>	<b>1,805</b>	<b>1,652</b>	<b>1,694</b>	<b>647</b>	<b>271</b>	<b>135</b>	<b>100</b>	<b>25</b>	<b>60</b>	<b>40</b>	<b>35</b>	<b>5</b>	<b>22,328</b>
<b>VERTICAL DEVELOPMENT</b>																							
Escape-way rises	m	8	38	6	41	19	54	24	56	41	24	60	37	-	-	-	-	-	-	-	-	-	408
Ventilation rises	m	-	58	16	-	82	39	36	15	54	47	16	31	-	-	-	-	-	-	-	-	-	393
<b>Total Vertical</b>	<b>m</b>	<b>8</b>	<b>96</b>	<b>22</b>	<b>41</b>	<b>100</b>	<b>94</b>	<b>60</b>	<b>71</b>	<b>95</b>	<b>70</b>	<b>76</b>	<b>68</b>	-	-	-	-	-	-	-	-	-	<b>801</b>
<b>LONGHOLE DRILLING</b>																							
	<b>km</b>	<b>0</b>	<b>2</b>	<b>0</b>	<b>10</b>	<b>13</b>	<b>19</b>	<b>20</b>	<b>20</b>	<b>19</b>	<b>19</b>	<b>25</b>	<b>22</b>	<b>20</b>	<b>18</b>	<b>15</b>	<b>21</b>	<b>23</b>	<b>17</b>	<b>14</b>	<b>8</b>	<b>1</b>	<b>308</b>
<b>TONNES</b>																							
<b>Waste</b>	<b>kt</b>	<b>89</b>	<b>120</b>	<b>99</b>	<b>90</b>	<b>70</b>	<b>83</b>	<b>76</b>	<b>73</b>	<b>76</b>	<b>86</b>	<b>64</b>	<b>63</b>	<b>12</b>	<b>6</b>	<b>5</b>	<b>4</b>	<b>1</b>	<b>2</b>	<b>1</b>	<b>1</b>	<b>0</b>	<b>1,020</b>
Ore - Development	kt	-	11	29	37	43	36	37	40	40	31	37	37	20	6	-	-	-	-	-	-	-	403
Ore - Stope	kt	-	-	-	58	70	120	134	127	144	146	145	147	146	126	126	116	121	128	104	69	31	2,056
<b>Ore - Total</b>	<b>kt</b>	<b>-</b>	<b>11</b>	<b>29</b>	<b>95</b>	<b>112</b>	<b>156</b>	<b>171</b>	<b>166</b>	<b>184</b>	<b>177</b>	<b>182</b>	<b>184</b>	<b>165</b>	<b>132</b>	<b>126</b>	<b>116</b>	<b>121</b>	<b>128</b>	<b>104</b>	<b>69</b>	<b>31</b>	<b>2,459</b>
<b>Total Ore and Waste</b>	<b>kt</b>	<b>89</b>	<b>131</b>	<b>128</b>	<b>185</b>	<b>182</b>	<b>239</b>	<b>246</b>	<b>239</b>	<b>261</b>	<b>263</b>	<b>246</b>	<b>247</b>	<b>177</b>	<b>138</b>	<b>131</b>	<b>119</b>	<b>122</b>	<b>130</b>	<b>106</b>	<b>70</b>	<b>31</b>	<b>3,480</b>
<b>HAULAGE (to ROM/DUMP)</b>																							
	<b>tkm</b>	<b>100</b>	<b>168</b>	<b>193</b>	<b>285</b>	<b>295</b>	<b>407</b>	<b>444</b>	<b>454</b>	<b>525</b>	<b>558</b>	<b>541</b>	<b>579</b>	<b>419</b>	<b>332</b>	<b>329</b>	<b>259</b>	<b>205</b>	<b>328</b>	<b>287</b>	<b>194</b>	<b>87</b>	<b>6,990</b>
<b>PASTE FILL</b>																							
	<b>'000 m3</b>	<b>-</b>	<b>-</b>	<b>-</b>	<b>3</b>	<b>8</b>	<b>44</b>	<b>50</b>	<b>46</b>	<b>51</b>	<b>57</b>	<b>65</b>	<b>66</b>	<b>59</b>	<b>51</b>	<b>56</b>	<b>41</b>	<b>15</b>	<b>42</b>	<b>31</b>	<b>30</b>	<b>13</b>	<b>729</b>
<b>ORE SUMMARY</b>																							
Tonnes	kt	-	11	29	95	112	156	171	166	184	177	182	184	165	132	126	116	121	128	104	69	31	2,459
Grade	g/t Au	-	5.2	4.7	4.6	4.9	4.3	5.1	4.7	5.6	5.7	5.2	5.0	4.4	4.2	3.8	4.3	5.1	5.2	5.6	4.9	4.2	4.9
Mined ounces	koz	-	1.8	4.4	14.0	17.8	21.7	28.1	25.3	33.4	32.2	30.7	29.6	23.2	17.8	15.3	16.1	19.8	21.4	18.8	11.0	4.2	387
Produced ounces (effective)	koz	-	1.5	3.6	11.6	14.8	18.1	23.4	21.0	27.8	26.8	25.5	24.6	19.2	14.8	12.7	13.4	16.5	17.7	15.6	9.1	3.5	321

Table 4: Schedule Physicals



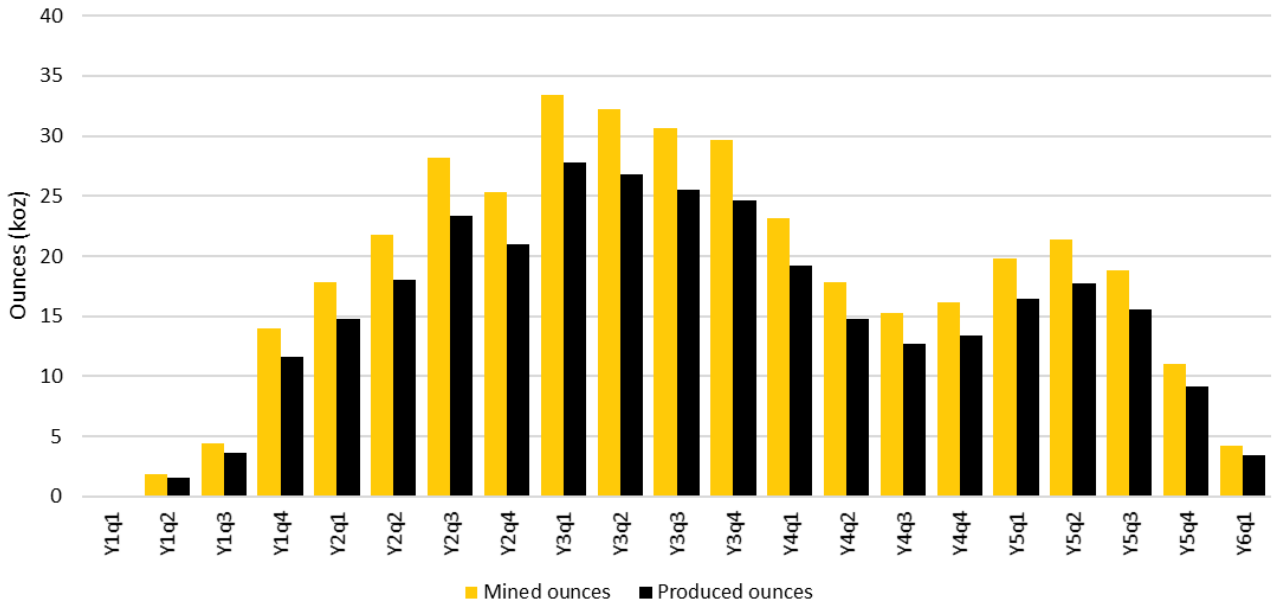

Figure 8: Recovery Schedule

## Processing

Tabakoroni open pit ore is currently processed through a toll-treatment arrangement at Syama and forms the basis for processing the underground sulphide ore. The current Syama Oxide Processing plant has a throughput capacity of 1.5Mt per annum of oxide material.

Over the past 12 years, 39 samples from Tabakoroni have been metallurgically tested to determine the ideal processing route. Like Syama, the underground orebody is double refractory in nature. Unlike Syama, Tabakoroni also contains gravity recoverable gold. Consequently, the logical route is a gravity-float-roast-leach. Using test work and Syama plant data, average recovery of 83% has been determined. Further variability float-roast-leach test work is in progress to confirm and optimise this value.

The Syama operation currently consists of two processing trains: a 2.4Mtpa sulphide float-roast-leach circuit and a 1.5Mtpa oxide gravity-leach circuit. As oxide ore may be depleted by 2022, the existing 1.5Mtpa oxide comminution circuit can be utilised to crush and grind Tabakoroni ore. Comminution modelling conducted as part of the Study revealed the comminution circuit capacity to be 1.0Mtpa when processing the harder Tabakoroni sulphide ore. As this exceeds the planned Tabakoroni mining rate, Syama Underground ore could be blended to utilise this capacity.

Five processing options were reviewed as part of the Study; two options to upgrade the current Syama sulphide circuit to handle the combined Syama and Tabakoroni throughput and three options to convert the current oxide plant to process Tabakoroni sulphide ore. The preferred option for the Study, providing a balance between capital expenditure, recovery, circuit stability, operating cost and flexibility to retain capability to process future oxide ore is to convert the oxide plant for sulphide duty including flash flotation and dedicated float cells as shown in Figure 9. The modified flowsheet is shown in Figure 10, with changes highlighted. From here the concentrate will join the current Syama sulphide concentrate recovery circuit for processing sulphide ore.



Resolute

# ASX Announcement

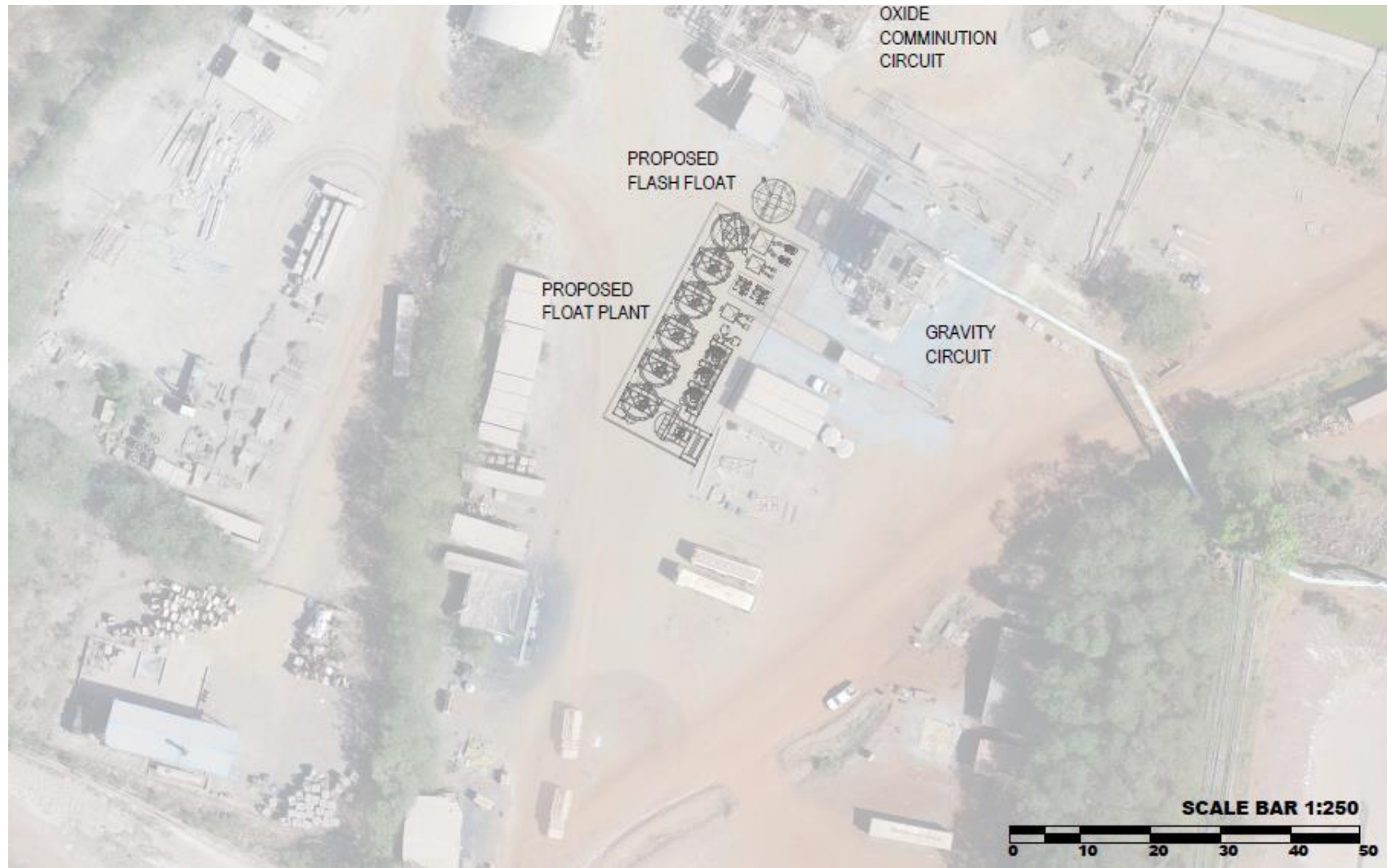

Figure 9: Oxide plant with additional float circuit





Resolute

# ASX Announcement

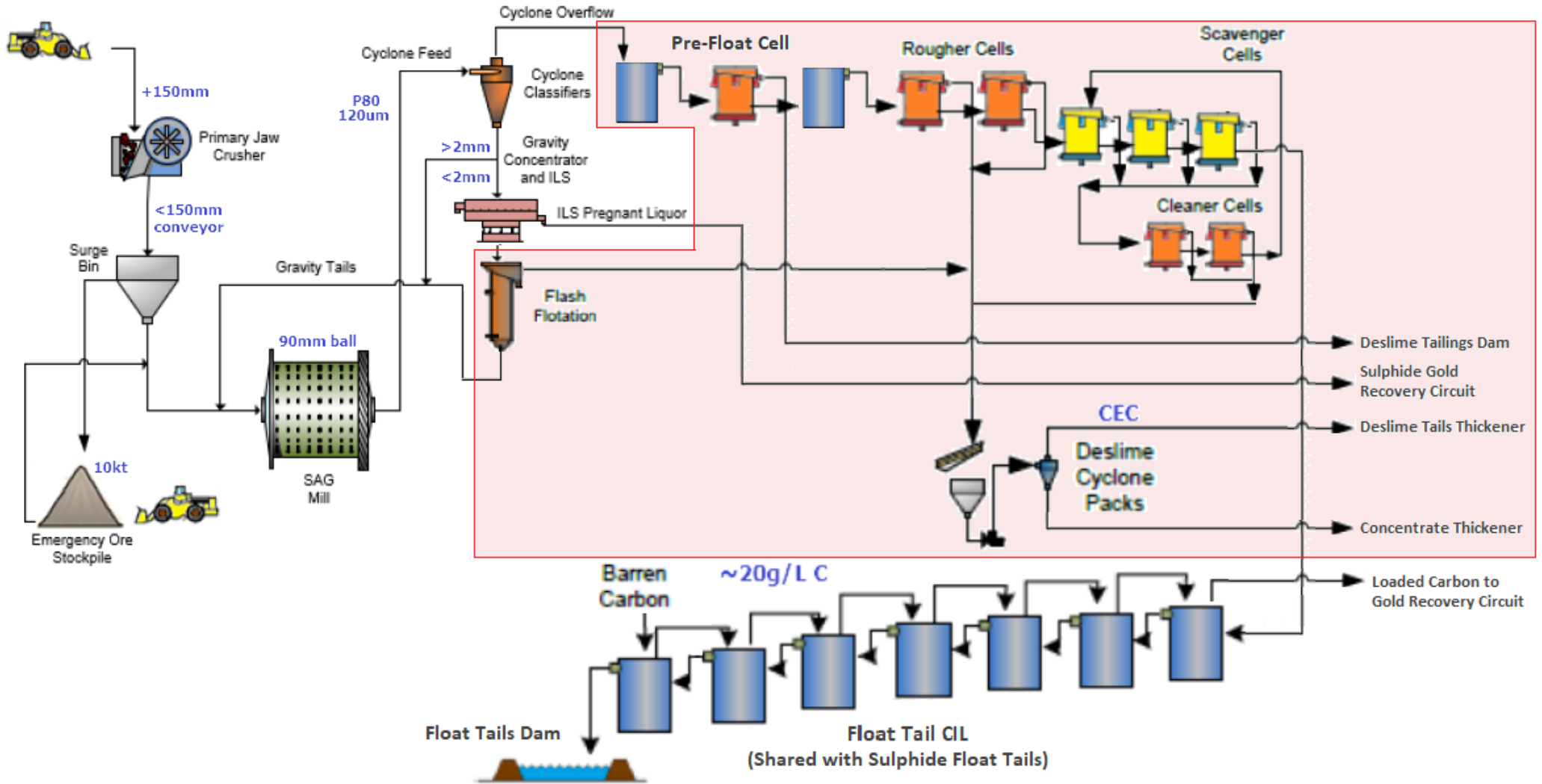

Figure 10: Tabakoroni process flow sheet



## Capital Cost

The LOM capital costs associated with Study are summarised below in Table 5.

Cost Category	Capital Cost US\$m
Underground Mining	30.3
Treatment	20.4
<b>Infrastructure (power, paste plant, etc)</b>	12.6
Pre-production Operating Costs	23.1
<b>Total Project Capital</b>	<b>86</b>
Sustaining Capital	32
<b>Total LOM Capital</b>	<b>118</b>

**Table 5: Capital expenditure summary**

Project capital expenditure estimates have been prepared by Resolute based on Study estimates provided by Outotec (treatment, paste plant) and similar capital projects completed at Syama. These capital estimates have been consolidated and built into an economic valuation model prepared by Practara for the Study.

A contractor operated model was assumed, based on current contracts in place for both Syama and Tabakoroni, reducing the upfront capital requirement for equipment. The current Tabakoroni open pit infrastructure, Syama camp and medical facilities will be utilised with daily commute to the Tabakoroni mine site. Temporary accommodation and emergency security and medical facilities will be provided at Tabakoroni. Further studies will evaluate the potential benefit of owner purchased equipment scenarios. The commercial production date has been estimated at 14 months after commencement of the decline development. Operating cost incurred prior to this date was capitalised. All capital expenditure incurred post commercial production consist of underground decline and infrastructure development and has been reported as sustaining capital.

## Operating Cost

### Mining Operating Cost

The mining cost estimate is based on quantities and timelines derived from the mining schedule and fixed and variable rates as per current operating and contract schedules from both Syama and Tabakoroni.

Costing has been based on the following assumptions:

- Contract mining and ore haulage to Syama for LOM
- Owner management and technical services for LOM
- Existing contract rates already in place for items such as explosives, diesel and cement

Costs have been estimated from:

- Contractor mining costs from Resolute's Syama Underground mine development contract
- Ore haulage costs from Tabakoroni open pit haulage contract
- Paste fill cost from Outotec study input and local binder costs
- Resolute input costs from personnel and key consumables such as diesel, electrical power and cement for paste fill

Mining operating costs are those associated with ore development, stoping and ore haulage. It also includes a portion of mining overheads split between capital and operating costs based on tonnes mined.

The total mining operating cost averages US\$72.2/t ore mined and is an average between the two mining methods (paste fill stopes and open stopes mined with pillars), and excludes operating costs capitalised prior to commercial production.





Resolute

# ASX Announcement

## Processing Operating Cost

Operating cost for the plant is based on an assumed throughput of 1.0Mtpa and has been determined from the current Syama sulphide and oxide processing plants costs. Total operating costs is estimated at \$18.3/t for processing and \$11.6/t for General and Administration.

## Royalties

Government royalties and refining costs constitute approximately \$29m over LOM, derived from the sale of gold.

## Rehabilitation and Remediation

Rehabilitation and mine closure estimates have not been fully costed for the Study. Most of the surface rehabilitation has already been incorporated into the current open pit operation. In the economic evaluation model, it has been assumed that the sale of the mine site fixed plant will cover the remaining cost of rehabilitation and remediation work specific to the underground.

## Further Exploration opportunities at Tabakoroni and Syama

### Ongoing Tabakoroni Exploration

Drilling completed since the last resource estimate was predominantly an infill program which has resulted in an increase of 200,000oz in the updated underground resource detailed above.

The diamond drilling program at Tabakoroni has now moved focus to explore for extensions of the mineralisation down dip and along strike. Results to date from this drilling has confirmed extensions to the mineralisation with several encouraging high-grade gold intersections including bonanza grades of 5m @ 116.3g/t Au in hole TARD773W located deep underneath the Tabakoroni South open pit (refer to Figure 11). Other notable intersections include:

TADD730	9m @ 9.6g/t Au from 185m
TADD732	4m @ 6.4g/t Au from 188m
TADD734	4m @ 72.8g/t Au from 209m
TADD778	17m @ 3.1g/t Au from 250m
TADD780	7m @ 10.5g/t Au from 405m
	7m @ 4.8g/t Au from 356m
TADD781	9m @ 5.2g/t Au from 443m
TARD773W	5m @ 116.3g/t Au from 222m

These drill results prove the down dip extensions of the mineralisation at Tabakoroni is of sufficient grade to support an underground mining operation. Diamond drilling will continue throughout 2020 continuing to expand the mineral resources at Tabakoroni.

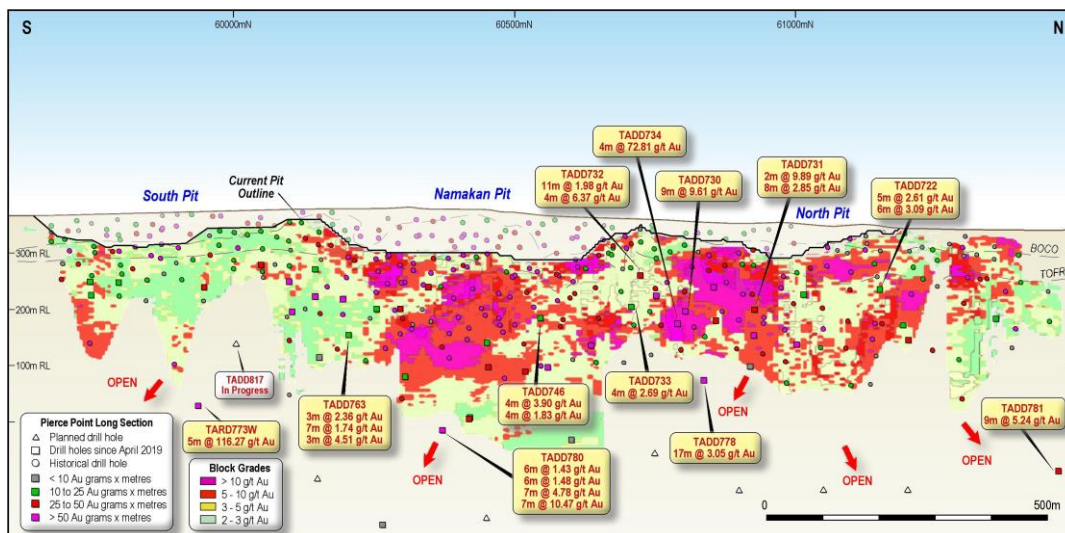

Figure 11: Tabakoroni Longitudinal Section with Resource Model and drilling pierce points.



## Syama Oxide Exploration

Resolute is undertaking an accelerated oxide exploration programs in 2020 to expand oxide resources which is expected to extend the mine life of the Syama oxide circuit.

Results from exploration in the first quarter this year were reported on 16 April 2020 with excellent drill intersections returned from the Syama Northern Pits area and oxide targets adjacent to Tabakoroni. Recent exploration efforts have followed up on the shallow results east of the Tabakoroni pit with continued success.

## Tabakoroni Oxide Targets

RC drilling programs undertaken in the first quarter of 2020 identified zones of shallow oxide mineralisation to the east of the Tabakoroni pit and adjacent to the Tabakoroni “Porphyry Splay” pit. These encouraging results have been followed up with programs of infill RC drilling to provide sufficient hole density for resource estimation.

Recent drilling has continued the positive results in the area between the Tabakoroni pit and the “Porphyry Splay” pit (refer to Figure 12). Better results include:

TARC767	8m @ 5g/t Au from 61m
TARC772	7m @ 6.7g/t Au from 33m
TARC788	17m @ 1.9g/t Au from 84m
TARC791	4m @ 52.5g/t Au from 49m
TARC795	5m @ 6.5g/t Au from 64m
TARC799	14m @ 2.5g/t Au from 21m
TARC803	4m @ 7.1g/t Au from 31m
TARC805	10m @ 4.2g/t Au from 104

Mining during 2020 at the “Porphyry Splay” pit extracted over 40,000oz from a small shallow open pit which was in excess of expectations. The mineralisation which was high-grade but discontinuous in resource drilling proved to be more coherent after grade control drilling was completed. This led to the overperformance of the pit in both tonnes and grade.

The overperformance of the open pit mining at the “Porphyry Splay” pit encouraged the exploration team to re-evaluate the mineralisation interpretation of the Tabakoroni area and focus on resource remodelling. This work is in progress and the team is confident that the mineralisation footprint will be expanded sufficiently to support a restart to open pit mining activities.

It is expected that the small pit at “Porphyry Splay” will be deepened and expanded laterally to access newly modelled gold mineralisation. The ongoing drilling program continues to expand the mineralisation footprint around the current pits at Tabakoroni.





Resolute

## ASX Announcement

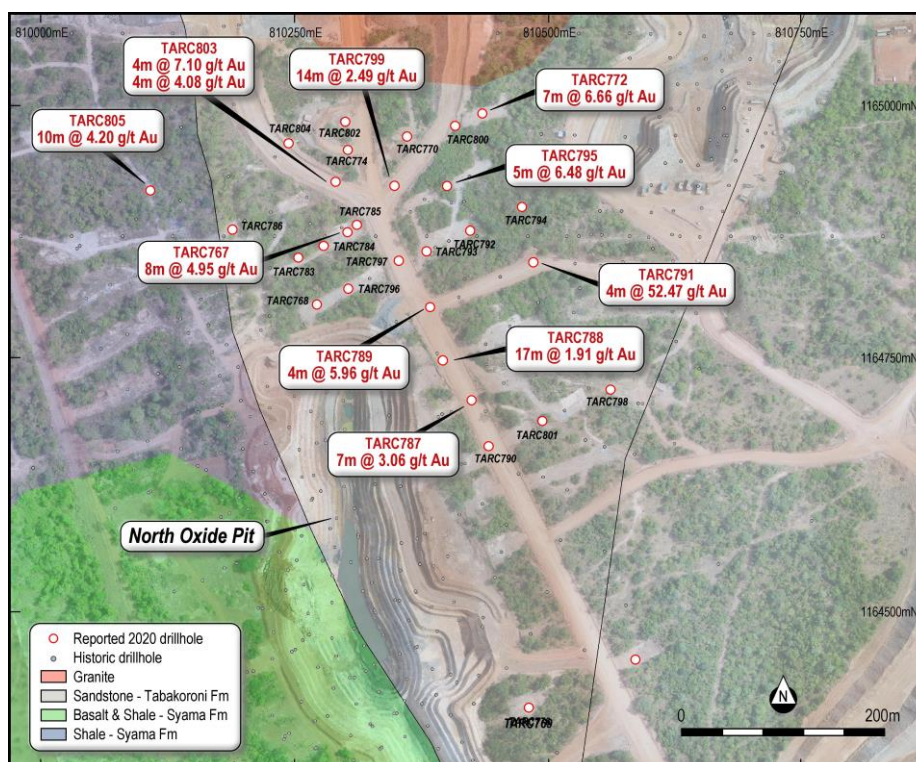

Figure 12: Tabakoroni North Pit and “Porphyry Splay” pit, drillhole locations on geology and drone imagery

Full details of the drilling results included in this announcement, including the JORC Code Table 1 Report, is included as Appendix 1.

### Syama Oxide Outlook

Gold production from the Syama oxide processing plant is currently sourced from stockpiles of oxide material which will be processed during 2021 and 2022. Open pit operations at Tabakoroni were concluded in May 2020 and will recommence in October 2020 at the Cashew, Tellem and Paysans satellite deposits located 5 to 10km south of the Syama processing infrastructure.

Resources at Cashew are currently approximately 100,000oz at 2g/t gold and at Paysans approximately 270,000oz at 1.7g/t gold (See ASX Announcement dated 17 January 2020).

As of 30 June 2020, oxide stockpiles at Syama are 3.4Mt @ 1.36g/t, containing 150,000oz of gold.

The results in this announcement and the continuing exploration program at Tabakoroni improves confidence in a likely restart of open pit mining operations at the Tabakoroni Porphyry Splay pit and the Gap zone in 2021.

The positive results from the exploration program at Syama North announced in April 2020 are being followed up with drilling programs with the aim of re-establishing open pit mining operations at the Syama northern Satellites.

Significant potential exists for further oxide deposits to be defined within the 85km strike length of Syama greenstones controlled by Resolute

Resolute’s exploration programs in Mali are continuing and have been supported by the extensive measures the Company has implemented in response to the COVID-19 pandemic.

### Environmental and Social Impact

Société des Mines de Finkolo SA (SOMIFI) operates Tabakoroni located in the Commune of Fourou, Cercle of Kadiolo and Administrative Region of Sikasso. The Tabakoroni open pit operation is a permitted operation (No. 2012-0057 MEA-SG) with a permitted haul road (No. 2012-0058 MEA-SG) linking it to. Tabakoroni is comprised of four open pits, the Namakan, South, Splay and North pits and these are nearing end of life. The Study considered underground extensions below the current Namakan and North open pits.



Resolute

## ASX Announcement

Digby Wells was appointed to undertake a study to characterise the biophysical and socio-economic environment of the project area, provide early indication of potential environmental and social risks and impacts and determine the Terms of Reference (ToR) for an Environmental and Social Impact Assessment (ESIA) process that will be required as part of the environmental permitting process. The ESIA will be undertaken in accordance with Malian Law No. 2012-015 of 27 February 2012 (the Mining Code) and the ESIA process will be followed in accordance with Law No. 01-020 / P-RM of 30 May 2011 on Pollution and Nuisance as well as the associated Decrees. The ToR validation site visit request was lodged with the national authorities and the site visit is expected to be completed prior to the end of 2020.

The development and exploitation of the Tabakoroni open pits were the subject of an ESIA and permitting process that concluded in 2012 with receipt of an environmental permit (No. 2012-0057 MEA-SG) for the mining operations and a separate permit for the haul road (No. 2012-0058 MEA-SG). The Study recognises that SOMIFI's operation is already permitted and therefore the ESIA will only cover new activities as part of the underground extension. These activities will, pending future exploration success, remain within the currently permitted fence line of Tabakoroni.

New activities include the mining of the underground sulphide deposits below the Namakan and North open pits. This will require two declines entering from one portal location within the existing Namakan open pit. The underground infrastructure will include return airways, sumps, stockpiles and escapeway access and rises for each decline. An explosives magazine will be located on surface. A paste fill batch plant will need to be constructed to provide cemented paste fill to support tunnel excavations and backfill stopping voids and open pit voids. Waste rock will be disposed underground in mined out stopes, when viable. Excess water and waste rock will be stored in the South, Splay and North open pits – studies and test work are underway to confirm the potential beneficial use of this water. Power capacity will need to be increased and power will be sourced from diesel generators to be relocated from Syama for which a power shed will be erected.

### Potential Study Enhancements

#### Additional Resources

Ongoing exploration success along strike and at depth has not been included into the Study, nor has underground potential below the Splay pit been assessed. On completion of the current drill program the Resource Estimate will be reviewed and will form the basis of future mining studies seeking to expand mining along strike and at depth. The current Study infrastructure is suitable to allow further expansion with minimal further investment.

#### Disposal of Underground Waste

There is an opportunity to dispose of waste underground, which was not incorporated into the haulage calculations. This has the potential to reduce mining costs and help to reduce the need to paste fill or use of open stopes.

#### Costs Estimation

The current evaluation model assumes contractor operating models. Further work is required to determine the benefit of owner operated scenarios.

Capital cost estimates were sourced from similar projects at Syama and Tabakoroni or were provided Study budget estimates by suppliers. Further refinement of these estimates could result in further improvements.

Operating cost estimates were sourced from current Syama and Tabakoroni contracts. Negotiation of Study specific operating and supply contracts could further enhance the operating cost estimates. Ongoing paste fill test work could further improve assumptions made in the study.

#### Mine Plan Optimisation

The repurposed oxide plant has a throughput capacity of 1.0Mtpa. The Study provides only 650ktpa to 750ktpa, which provides mining upside opportunity for Tabakoroni either through rescheduling, or through further exploration success.



Resolute

## ASX Announcement

Due to the relatively low mining production rate, there is ample spare capacity in the current equipment numbers, which could either be filled through further design or scheduling optimisation, or through additional exploration success providing additional mining areas.

Ground conditions continue to improve at depth, providing opportunity to increase both stope lengths and level spacing. Increased stope lengths increased production throughput and reduce slot rising and paste wall requirements. Increased level spacings reduce development requirements and can increase stope productivity. The basis of estimate for the study assumed a conservative 20m for both level spacing and maximum stoping length.

### Process Enhancement

The spare capacity in the process plant could either be filled with additional Tabakoroni ore or by supplementing with Syama underground or open pit sulphide ore. These options have not been included in the Study.

Ongoing variability and process optimisation test could further enhance the process recovery estimate of 83% used in the Study. Test work have shown recoveries of up to 87%, with a large gravity recovery component.

### Timeline and Investment Decision

Work is continuing to extend the Tabakoroni Underground Mineral Resources. This work is expected to allow for further refinements to the proposed mine plan and the delineation of an enlarged Ore Reserve for the Tabakoroni Underground. The results of this work will be published when available and will inform a future investment decision. The timing of any development of a Tabakoroni underground operation will be matched to the expected mine life of the existing Syama oxide operation and will be outlined in the Syama Life-of-Mine update to be completed and published during the current quarter.

For further information, contact:

#### John Welborn

#### *Managing Director and CEO*

Resolute Mining Limited

Telephone: +61 8 9261 6100 | Email: [contact@rml.com.au](mailto:contact@rml.com.au)

### Contact Information

#### Resolute

John Welborn, Managing Director & CEO

Telephone: +61 8 9261 6100

Email: [contact@rml.com.au](mailto:contact@rml.com.au)

Web: [www.rml.com.au](http://www.rml.com.au)

#### Berenberg (UK Corporate Broker)

Matthew Armitt / Jennifer Wyllie / Detlir Elezi

Telephone: +44 20 3207 7800

#### Tavistock (UK Public Relations)

Jos Simson / Emily Moss / Annabel de Morgan / Oliver Lamb

Telephone: +44 207 920 3150 / +44 778 855 4035

Email: [resolute@tavistock.co.uk](mailto:resolute@tavistock.co.uk)

### Follow Resolute



Authorised by Mr John Welborn, Managing Director & CEO

#### ASX/LSE: RSG Capital Summary

Fully Paid Ordinary Shares: 1,103,892,706  
Current Share Price: A\$0.99 as at  
13 October 2020  
Market Capitalisation: A\$1.09 billion

#### Board of Directors

Mr Martin Botha *Non-Executive Chairman*  
Mr John Welborn *Managing Director & CEO*  
Ms Yasmin Broughton *Non-Executive Director*  
Mr Mark Potts *Non-Executive Director*  
Ms Sabina Shugg *Non-Executive Director*  
Mr Peter Sullivan *Non-Executive Director*

#### Contact

**John Welborn** *Managing Director & CEO*  
Level 2, Australia Place | 15-17 William St  
Perth, Western Australia 6000  
T: +61 8 9261 6100 | F: +61 8 9322 7597  
E: [contact@rml.com.au](mailto:contact@rml.com.au)





Resolute

## ASX Announcement

### Competent Persons Statement

The information in this report that relates to the Exploration Results, Mineral Resources and Ore Reserves is based on information compiled by Mr Bruce Mowat, a member of The Australian Institute of Geoscientists. Mr Bruce Mowat has more than 5 years' experience relevant to the styles of mineralisation and type of deposit under consideration and to the activity which he is undertaking to qualify as a Competent Person, as defined in the 2012 Edition of the "Australasian Code for Reporting of Exploration Results, Mineral Resources and Ore Reserves" (the JORC Code). Mr Bruce Mowat is a full-time employee of the Resolute Mining Limited Group and holds equity securities in the Company. He has consented to the inclusion of the matters in this report based on his information in the form and context in which it appears. This information was prepared and disclosed under the JORC Code 2012 except where otherwise noted.

The information in this announcement that relates to the Mineral Resource estimate has been based on information and supporting documents prepared by Mrs Susan Havlin, a Competent Person who is a Member of The Australasian Institute of Mining and Metallurgy. Mrs Havlin is an employee of Optiro and has sufficient experience relevant to the style of mineralisation and type of deposit under consideration and to the activity which has been undertaken to qualify as a Competent Person. Mrs Havlin confirms that the Mineral Resource estimate is based on information in the supporting documents and consents to the inclusion in the report of the Mineral Resource estimate and related content based on the information in the form and context in which it appears

### About Resolute

Resolute is a successful gold miner with more than 30 years of experience as an explorer, developer and operator of gold mines in Australia and Africa which have produced more than 8 million ounces of gold. The Company trades on the Australian Securities Exchange (ASX) and the London Stock Exchange (LSE) under the ticker RSG.

Resolute currently operates the Syama Gold Mine in Mali and the Mako Gold Mine in Senegal. The Company is the owner of the Bibiani Gold Mine in Ghana. Resolute's guidance for 2020 has been set at production of 430,000 ounces of gold at an All-In Sustaining Cost of US\$980 per ounce.

### COVID-19 Business Update

Resolute is responding to the COVID-19 pandemic to ensure impacts are mitigated across all aspects of Company operations (see ASX Announcement dated 26 March 2020). Resolute continues to assess developments and update the Company's response with the highest priority on the safety and wellbeing of its employees, contractors and stakeholders. Further escalation of COVID-19, and the implementation of further government-regulated restrictions or extended periods of supply chain disruption, has the potential to negatively impact gold production, earnings, cash flow and the Company's balance sheet.

### Cautionary Statement about Forward-Looking Statements

This announcement includes certain statements, estimates and projections with respect to the future performances of Resolute. Such statements, estimates and projections reflect various assumptions concerning anticipated results, which assumptions may prove not to be correct. The projections are merely estimates by Resolute, of the anticipated future performance of Resolute's business based on interpretations of existing circumstances, and factual information and certain assumptions of economic results, which may prove to be incorrect. Such projections and estimates are not necessarily indicative of future performance, which may be significantly less favourable than as reflected herein. Accordingly, no representations are made as to the fairness, accuracy, correctness or completeness of the information contained in this announcement including estimates or projections and such statements, estimates and projections should not be relied upon as indicative of future value, or as a guarantee of value of future results. This announcement does not constitute an offer, invitation or recommendation to subscribe for or purchase securities in Resolute Mining Limited (ASX/LSE: RSG).



Resolute

## ASX Announcement

## Appendix 1: Recent drilling results

## Tabakoroni Oxide Drilling

Hole_ID	North (WGS)	East (WGS)	RL (m)	Dip	Azi (WGS)	EOH (m)	From (m)	To (m)	Width (m)	Au (g/t)
TARC767	1164874	810302	342	-55	67	131	61	69	8	4.95
TARC768	1164803	810272	343	-55	65	135	79	83	4	3.14
TARC772	1164991	810435	341	-56	62	120	33	40	7	6.66
TARC774	1164955	810302	343	-57	85	132	21	24	3	3.4
							55	58	3	3.32
TARC776	1164453	810586	352	-55	67	129	0	3	3	3.77
TARC783	1164850	810253	342	-60	67	132	104	106	2	6.37
TARC784	1164861	810278	342	-56	66	138	133	136	3	4.28
TARC785	1164882	810311	342	-50	65	120	61	65	4	1.77
							114	117	3	1.99
TARC787	1164709	810424	345	-62	65	128	54	61	7	3.06
							121	125	4	2.13
TARC788	1164747	810396	344	-55	245	126	22	31	9	0.82
							49	52	3	2.4
							84	101	17	1.91
TARC789	1164800	810383	343	-59	66	114	51	53	2	2.95
							106	110	4	5.96
TARC791	1164845	810485	343	-62	67	140	49	53	4	52.47
TARC792	1164876	810423	342	-56	64	102	17	21	4	1.92
							80	85	5	1.13
TARC793	1164855	810379	342	-56	65	132	105	116	11	0.94
TARC794	1164899	810474	341	-55	68	126	17	20	3	4.24
							28	35	7	0.95
							114	118	4	1.7
TARC795	1164920	810400	341	-60	67	102	64	69	5	6.48
TARC796	1164819	810303	342	-59	66	174	63	74	11	0.9
							146	148	2	2.52
TARC797	1164846	810354	343	-54	67	176	0	3	3	1.91
							39	42	3	1.84
							82	85	3	2.74
							113	120	7	0.97
TARC798	1164720	810562	344	-71	66	156	38	41	3	3.14
TARC799	1164902	810348	342	-55	67	126	21	35	14	2.49
							115	120	5	1.47
TARC801	1164687	810494	344	-67	68	180	136	138	2	6.31
							168	174	6	1.61
TARC802	1164999	810300	342	-55	65	156	32	34	2	5.99
							133	136	3	2.82
TARC803	1164923	810290	343	-60	67	150	31	35	4	7.1
							86	90	4	4.08
TARC805	1164898	810114	341	-60	66	228	104	114	10	4.2
							122	130	8	1.21
TARC806	1164765	810407	344	-70	66	132	90	96	6	2.83
TARC807	1164748	810393	344	-89	31	150	42	51	9	1.5
							139	145	6	1.07

Table 1: Recent drilling results from Tabakoroni Oxide targets

Notes to accompany table:

- Grid coordinates are WGS84 Zone 29 North
- RC intervals are sampled every 1m by dry riffle splitting or scoop to provide a 1-3kg sample
- Cut-off grade for reporting of intercepts is >1g/t Au with a maximum of 3m consecutive internal dilution included within the intercept; only intercepts >=3m are reported



Resolute

**ASX Announcement**

- Samples are analysed for gold by 30g fire assay fusion with AAS instrument finish, over-range results are reanalysed by 30g fire assay fusion with gravimetric finish.

**Tabakoroni Deeps Drilling**

Hole_ID	North (WGS)	East (WGS)	RL (m)	Dip	Azi (WGS)	EOH (m)	From (m)	To (m)	Width (m)	Au (g/t)
TADD730	1164269	810310	361	-56	63	230	185	194	9	9.61
TADD731	1164380	810244	356	-51	66	252.2	176	178	2	9.89
							195	203	8	2.85
TADD732	1164219	810311	368	-50	66	248	171	182	11	1.98
							188	192	4	6.37
TADD733	1164167	810315	367	-50	64	271.5	210	214	4	2.69
TADD734	1164272	810313	361	-64	72	273.7	209	213	4	72.81
TADD735	1164639	810163	343	-55	66	287	163	174	11	1.21
TADD746	1164007	810330	372	-51	67	329.2	221	225	4	3.9
							241	245	4	1.83
TADD763	1163689	810479	384	-56	62	321.3	114	117	3	2.36
							172	179	7	1.74
							276	279	3	4.51
TADD778	1164309	810284	357	-67	67	321.4	250	267	17	3.05
TADD780	1163857	810382	379	-76	63	450.5	326	332	6	1.43
							342	348	6	1.48
							356	363	7	4.78
							391	393	2	3.32
							405	412	7	10.47
TADD781	1164858	810035	341	-68	64	474	443	452	9	5.24
TADD782	1163658	810180	365	-67	46	849.4	664	667	3	1.72
						849.4	777	784	7	1.04
TADD782W1	1163658	810180	365	-67	46	674.6	656	667	11	1.57
TADD790	1164663	810442	345	-65	65	406.5	84	89	5	1.42
						406.5	100	103	3	3.17
TARC737	1163257	811204	357	-55	65	115	110	112	2	4.34
TARC771	1163495	810482	376	-60	65	180	24	30	6	1.36
TARC775	1163303	810508	368	-62	58	180	39	42	3	3.05
							125	128	3	3.97
TARC779	1163173	810616	371	-59	66	132	29	35	6	1.87
							50	52	2	3.72
							87	92	5	3.64
TARD722	1164593	810177	347	-54	63	235.6	53	57	4	3.58
							130	135	5	2.61
							176	182	6	3.09
TARD773	1163423	810501	371	-60	64	369	137	144	7	3.96
							222	224	2	32.06
							256	260	4	1.77
TARD773W*	1163423	810501	371	-60	64	515.5	368	373	5	116.27

**Table 2: Recent drilling results from Tabakoroni Deeps***Notes to accompany table:*

- Grid coordinates are WGS84 Zone 29 North
- RC intervals are sampled every 1m by dry riffle splitting or scoop to provide a 1-3kg sample
- Diamond core are sampled every 1m by cutting the core in half to provide a 2-4kg sample
- Cut-off grade for reporting of intercepts is >1g/t Au with a maximum of 3m consecutive internal dilution included within the intercept; only intercepts >=2m and >5 gram x metres are reported
- Samples are analysed for gold by 30g fire assay fusion with AAS instrument finish; over-range results are reanalysed by 30g fire assay fusion with gravimetric finish. \*TARD773W interval has been analysed by 1kg screen fire assay with AAS instrument finish.





Table 1 - Section 1: Tabakoroni Sampling Techniques and Data

CRITERIA	JORC CODE EXPLANATION	COMMENTARY
<b>Sampling techniques</b>	<ul style="list-style-type: none"> <li>Nature and quality of sampling (e.g. cut channels, random chips, or specific specialised industry standard measurement tools appropriate to the minerals under investigation, such as down hole gamma sondes, or handheld XRF instruments, etc.). These examples should not be taken as limiting the broad meaning of sampling.</li> <li>Include reference to measures taken to ensure sample representivity and the appropriate calibration of any measurement tools or systems used.</li> <li>Aspects of the determination of mineralisation that are Material to the Public Report.</li> <li>In cases where 'industry standard' work has been done this would be relatively simple (e.g. 'reverse circulation drilling was used to obtain 1 m samples from which 3 kg was pulverised to produce a 30 g charge for fire assay'). In other cases, more explanation may be required, such as where there is coarse gold that has inherent sampling problems. Unusual commodities or mineralisation types (e.g. submarine nodules) may warrant disclosure of detailed information.</li> </ul>	<p>The samples were collected from reverse circulation (RC) drill holes.</p> <p>RC samples were collected on 1 m intervals by riffle split (dry) or by scoop (wet), to obtain a 1-3kg sample which was sent to the laboratory for crushing, splitting and pulverising to provide a 30g charge for analysis.</p> <p>Sampling and sample preparation protocols are industry standard and are deemed appropriate by the Competent Person.</p>
<b>Drilling techniques</b>	<ul style="list-style-type: none"> <li>Drill type (e.g. core, reverse circulation, open-hole hammer, rotary air blast, auger, Bangka, sonic, etc.) and details (e.g. core diameter, triple or standard tube, depth of diamond tails, face-sampling bit or other type, whether core is oriented and if so, by what method, etc.).</li> </ul>	Drill types used include reverse circulation.
<b>Drill sample recovery</b>	<ul style="list-style-type: none"> <li>Method of recording and assessing core and chip sample recoveries and results assessed.</li> <li>Measures taken to maximise sample recovery and ensure representative nature of the samples.</li> <li>Whether a relationship exists between sample recovery and grade and whether sample bias may have occurred due to preferential loss/gain of fine/coarse material.</li> </ul>	<p>Appropriate measures are taken to maximise sample recovery and ensure the representative nature of the samples.</p> <p>No apparent relationship is noted between sample recovery and grade.</p>
<b>Logging</b>	<ul style="list-style-type: none"> <li>Whether core and chip samples have been geologically and geotechnically logged to a level of detail to support appropriate Mineral</li> </ul>	Drill holes were geologically logged by geologists for colour, grainsize, lithology, minerals, alteration and weathering on geologically-dominated intervals.



	<p><i>Resource estimation, mining studies and metallurgical studies.</i></p> <ul style="list-style-type: none"> <li><i>Whether logging is qualitative or quantitative in nature. Core (or costean, channel, etc.) photography.</i></li> <li><i>The total length and percentage of the relevant intersections logged.</i></li> </ul>	<p>Holes were logged in their entirety (100%) and this logging was considered reliable and appropriate.</p>
<p><b>Sub-sampling techniques and sample preparation</b></p>	<ul style="list-style-type: none"> <li><i>If core, whether cut or sawn and whether quarter, half or all core taken.</i></li> <li><i>If non-core, whether riffled, tube sampled, rotary split, etc. and whether sampled wet or dry.</i></li> <li><i>For all sample types, the nature, quality and appropriateness of the sample preparation technique.</i></li> <li><i>Quality control procedures adopted for all sub-sampling stages to maximise representivity of samples.</i></li> <li><i>Measures taken to ensure that the sampling is representative of the in-situ material collected, including for instance results for field duplicate/second-half sampling.</i></li> <li><i>Whether sample sizes are appropriate to the grain size of the material being sampled.</i></li> </ul>	<p>Reverse circulation samples were collected on 1m intervals by riffle split (dry) or by scoop (wet) to obtain a 1-3kg sample.</p> <p>Sample preparation includes oven drying, crushing to 10mm, splitting and pulverising to 85% passing -75µm. These preparation techniques are deemed to be appropriate to the material being sampled.</p> <p>Reverse circulation field duplicates were collected by the company at a rate of 1:20 samples.</p> <p>Sampling, sample preparation and quality control protocols are of industry standard and all attempts were made to ensure an unbiased representative sample was collected. The methods applied in this process were deemed appropriate by the Competent Person.</p>
<p><b>Quality of assay data and laboratory tests</b></p>	<ul style="list-style-type: none"> <li><i>The nature, quality and appropriateness of the assaying and laboratory procedures used and whether the technique is considered partial or total.</i></li> <li><i>For geophysical tools, spectrometers, handheld XRF instruments, etc., the parameters used in determining the analysis including instrument make and model, reading times, calibrations factors applied and their derivation, etc.</i></li> <li><i>Nature of quality control procedures adopted (e.g. standards, blanks, duplicates, external laboratory checks) and whether acceptable levels of accuracy (i.e. lack of bias) and precision have been established.</i></li> </ul>	<p>All samples were dispatched to ALS Bamako for gold analysis by 30g fire assay fusion with AAS instrument finish (method code Au-AA25). Over-range results were re-analysed and reported by 30g fire assay fusion with gravimetric finish (method code Au-GRA21). The analytical method was appropriate for the style of mineralisation.</p> <p>No geophysical tools were used to determine elemental concentrations.</p> <p>Quality control (QC) procedures included the use of certified standards (1:40), non-certified sand blanks (1:40) and reverse circulation field duplicates (1:20).</p> <p>Laboratory quality control data, including laboratory standards, blanks, duplicates, repeats, grind size results and sample weights were also captured into the digital database.</p> <p>Analysis of the QC sample assay results indicates that an acceptable level of accuracy and precision has been achieved.</p>
<p><b>Verification of sampling and assaying</b></p>	<ul style="list-style-type: none"> <li><i>The verification of significant intersections by either independent or alternative company personnel.</i></li> <li><i>The use of twinned holes.</i></li> </ul>	<p>Verification of significant intersections have been completed by company personnel and the Competent Person.</p> <p>No drill holes within the resource area were twinned.</p>



	<ul style="list-style-type: none"> <li>Documentation of primary data, data entry procedures, data verification, data storage (physical and electronic) protocols.</li> <li>Discuss any adjustment to assay data.</li> </ul>	<p>Drill holes were logged into digital templates with lookup codes, validated and then compiled into a relational SQL 2012 database using DataShed data management software. The database has verification protocols which are used to validate the data entry. The drill hole database is backed up on a daily basis to the head office server.</p> <p>Assay result files were reported by the laboratory in PDF and CSV format and imported into the SQL database without adjustment or modification.</p>
<b>Location of data points</b>	<ul style="list-style-type: none"> <li>Accuracy and quality of surveys used to locate drill holes (collar and down-hole surveys), trenches, mine workings and other locations used in Mineral Resource estimation.</li> <li>Specification of the grid system used.</li> <li>Quality and adequacy of topographic control.</li> </ul>	<p>Collar coordinates were picked up in UTM (WGS84) by staff surveyors using an RTK DGPS with an expected accuracy of <math>\pm 0.05\text{m}</math>; elevations were height above EGM96 geoid.</p> <p>Down hole surveys were collected at 10m intervals using a Reflex EZ-Gyro north seeking instrument.</p> <p>Coordinates and azimuths are reported in UTM WGS84 Zone 29 North.</p> <p>Tabakoroni drill holes were translated to local mine grid coordinates using 1 point and rotation.</p> <p>Local topographic control is via LIDAR surveys, satellite photography and drone UAV aerial survey.</p>
<b>Data spacing and distribution</b>	<ul style="list-style-type: none"> <li>Data spacing for reporting of Exploration Results.</li> <li>Whether the data-spacing and distribution is sufficient to establish the degree of geological and grade continuity appropriate for the Mineral Resource and Ore Reserve estimation procedure(s) and classifications applied.</li> <li>Whether sample compositing has been applied.</li> </ul>	<p>Drill hole spacing was sufficient to demonstrate geological and grade continuity appropriate for a Mineral Resource and the classifications applied under the 2012 JORC Code.</p> <p>The appropriateness of the drill spacing was reviewed by the geological technical team, both on site and head office. This was also reviewed by the Competent Person.</p> <p>Samples were collected on 1m intervals; no sample compositing is applied during sampling.</p>
<b>Orientation of data in relation to geological structure</b>	<ul style="list-style-type: none"> <li>Whether the orientation of sampling achieves unbiased sampling of possible structures and the extent to which this is known, considering the deposit type.</li> <li>If the relationship between the drilling orientation and the orientation of key mineralised structures is considered to have introduced a sampling bias, this should be assessed and reported if material.</li> </ul>	<p>Holes were drilled predominantly perpendicular to mineralised domains where possible.</p> <p>No orientation-based sampling bias has been identified in the data.</p>
<b>Sample security</b>	<ul style="list-style-type: none"> <li>The measures taken to ensure sample security.</li> </ul>	<p>Samples were collected from the drill site and stored on site. All samples were individually bagged and labelled with unique sample identifiers, then securely dispatched to the laboratories. All aspects of sampling and dispatch process were supervised and tracked by SOMIFI personnel.</p>
<b>Audits or reviews</b>	<ul style="list-style-type: none"> <li>The results of any audits or reviews of sampling techniques and data.</li> </ul>	<p>External audits of procedures indicate protocols are within industry standards.</p>





## Section 2 Reporting of Exploration Results

CRITERIA	JORC CODE EXPLANATION	COMMENTARY
<b>Mineral tenement and land tenure status</b>	<ul style="list-style-type: none"> <li>Type, reference name/number, location and ownership including agreements or material issues with third parties such as joint ventures, partnerships, overriding royalties, native title interests, historical sites, wilderness or national park and environmental settings.</li> <li>The security of the tenure held at the time of reporting along with any known impediments to obtaining a licence to operate in the area.</li> </ul>	<p>Drilling at Syama was conducted within the Malian Exploitation Concession Permit PE 93/003 which covers an area of 200.6 Km<sup>2</sup>.</p> <p>Resolute Mining Limited has an 80% interest in the Syama project and the Exploitation Permit PE 93/003, on which it is based, through its Malian subsidiary, Société des Mines de Syama SA (SOMISY). The Malian Government holds a free carried 20% interest in SOMISY.</p> <p>Tabakoroni drilling was completed within the Finkolo-Tabakoroni Exploitation Licence PE 13/19. Resolute Mining Limited has an 85% interest in Exploitation Permit PE 13/19, through its Malian subsidiary, Société des Mines de Finkolo SA (SOMIFI). The Malian Government holds a free carried 10% interest in SOMIFI and a free carried 5% interest is held privately.</p> <p>The Permits are held in good standing. Malian mining law provides that all Mineral Resources are administered by DNGM (Direction Nationale de la Géologie et des Mines) or National Directorate of Geology and Mines under the Ministry of Mines, Energy and Hydrology.</p>
<b>Exploration done by other parties</b>	<ul style="list-style-type: none"> <li>Acknowledgment and appraisal of exploration by other parties.</li> </ul>	<p>The Syama deposit was originally discovered by a regional geochemical survey undertaken by the Direction National de Géologie et des Mines (DNGM) with assistance from the United Nations Development Program (UNDP) in 1985. There had also been a long history of artisanal activities on the hill where an outcropping chert horizon originally marked the present day position of the open pit.</p> <p>BHP during 1987-1996 sampled pits, trenches, auger, RC and diamond drill holes across Syama prospects. Randgold Resources Ltd during 1996-2000 sampled pits, trenches, auger, RAB, RC and diamond drill holes across Syama prospects.</p> <p>Etruscan Resources Inc explored Tabakoroni during 2002-2003 by auger, aircore, RC and diamond drill hole tails. The Tabakoroni area was previously explored Barrick Gold (1990) by auger, pits, trenches, RAB and diamond core drilling.</p>
<b>Geology</b>	<ul style="list-style-type: none"> <li>Deposit type, geological setting and style of mineralisation.</li> </ul>	<p>The Syama Project is found on the northern margin of the Achaean-Proterozoic Leo Shield which forms the southern half of the West African Craton. The project area straddles the boundary between the Kadiana-Madinani terrane and the Kadiolo terrane. The Kadiana-Madinani terrane is dominated by greywackes and a narrow belt of interbedded basalt and argillite. The Kadiolo terrane comprises polymictic conglomerate and sandstone that were sourced from the Kadiana-Madinani terrane and deposited in a late- to syntectonic basin.</p>



		<p>Prospects are centred on the NNE striking, west dipping, Syama-Bananso Fault Zone and Birimian volcano-sedimentary units of the Syama Formation. The major commodity being sought is gold.</p> <p>The Tabakoroni deposit is hosted in upright tightly folded greenstone rocks of the Syama Formation, comprising interbedded basalt and sediment units, and an overlying complex sequence of deep marine and turbiditic sediments. The sequence overlying the basalts contains interbedded carbonaceous units (silts and shales) that are preferentially deformed, and which form the Tabakoroni Main Shear Zone (TMSZ) that lies along the approximate contact of the greenstone-sediment sequence. Gold mineralisation occurs within the TMSZ associated with quartz vein stockworks and stylonitic quartz reefs.</p>
<p><b>Drill hole Information</b></p>	<ul style="list-style-type: none"> <li>• <i>A summary of all information material to the understanding of the exploration results including a tabulation of the following information for all Material drill holes:</i> <ul style="list-style-type: none"> <li>○ <i>easting and northing of the drill hole collar</i></li> <li>○ <i>elevation or RL (Reduced Level – elevation above sea level in metres) of the drill hole collar</i></li> <li>○ <i>dip and azimuth of the hole</i></li> <li>○ <i>down hole length and interception depth</i></li> <li>○ <i>whole length.</i></li> </ul> </li> <li>• <i>If the exclusion of this information is justified on the basis that the information is not Material and this exclusion does not detract from the understanding of the report, the Competent Person should clearly explain why this is the case.</i></li> </ul>	<p>All information, including easting, northing, elevation, dip, azimuth, coordinate system, drill hole length, intercept length and depth are measured and recorded in UTM Zone 29 WGS84.</p> <p>The Syama belt is mostly located on the Tengrela 1/200,000 topo sheet (Sheet NC 29-XVIII).</p> <p>The Tabakoroni local grid has been tied to the UTM Zone 29 WGS84 co-ordinate system.</p> <p>Spectrum Survey &amp; Mapping from Australia established survey control at Tabakoroni using AusPos online processing to obtain an accurate UTM Zone 29 (WGS84) and 'above geoid' RL for the origin of the survey control points.</p> <p>Accuracy of the survey measurements is considered to meet acceptable industry standards.</p> <p>Drill hole information has been tabulated for this release in the intercepts table of the accompanying text.</p> <p>For completeness the following information about the drill holes is provided:</p> <ul style="list-style-type: none"> <li>• Easting, Northing and RL of the drill hole collars are measured and recorded in UTM Zone 29 (WGS84)</li> <li>• Dip is the inclination of the drill hole from horizontal. A drill hole drilled at -60° is 60° from the horizontal</li> <li>• Down hole length is the distance down the inclination of the hole and is measured as the distance from the horizontal to end of hole</li> <li>• Intercept depth is the distance from the start of the hole down the inclination of the hole to the depth of interest or assayed interval of interest.</li> </ul>
<p><b>Data aggregation methods</b></p>	<ul style="list-style-type: none"> <li>• <i>In reporting Exploration Results, weighting averaging techniques, maximum and/or minimum grade truncations (e.g. cutting of high grades) and cut-off grades are usually Material and should be stated.</i></li> <li>• <i>Where aggregate intercepts incorporate short lengths of high-grade results and longer lengths of low-grade results, the procedure used for such aggregation should be stated and some typical examples of such aggregations should be shown in detail.</i></li> </ul>	<p>Exploration results reported in this announcement are tabulated using the following parameters:</p> <ul style="list-style-type: none"> <li>• Grid coordinates are WGS84 Zone 29 North</li> <li>• Cut-off grade for reporting of intercepts is <math>\geq 1</math>g/t Au</li> <li>• No top cut of individual assays prior to length weighted compositing of the reported intercept has been applied</li> <li>• Maximum 3m consecutive internal dilution included within the intercept</li> </ul>



	<ul style="list-style-type: none"> <li>The assumptions used for any reporting of metal equivalent values should be clearly stated.</li> </ul>	Metal equivalent values are not used in reporting.
<b>Relationship between mineralisation widths and intercept lengths</b>	<ul style="list-style-type: none"> <li>These relationships are particularly important in the reporting of Exploration Results.</li> <li>If the geometry of the mineralisation with respect to the drill hole angle is known, its nature should be reported.</li> <li>If it is not known and only the down hole lengths are reported, there should be a clear statement to this effect (e.g. 'down hole length, true width not known').</li> </ul>	<p>The Syama mineralisation is steeply dipping at approximately 60 degrees from the horizontal.</p> <p>The majority of the Tabakoroni mineralisation is vertical. There is one domain which dips at 45o to the west.</p> <p>The majority of the drill holes are planned at a general inclination of -60 degrees east and as close to perpendicular to the ore zone as possible.</p> <p>At the angle of the drill holes and the dip of the ore zones, the reported intercepts will be slightly more than true width.</p>
<b>Diagrams</b>	<ul style="list-style-type: none"> <li>Appropriate maps and sections (with scales) and tabulations of intercepts should be included for any significant discovery being reported. These should include, but not be limited to a plan view of drill hole collar locations and appropriate sectional views.</li> </ul>	Relevant maps, diagrams and tabulations are included in the body of text.
<b>Balanced reporting</b>	<ul style="list-style-type: none"> <li>Where comprehensive reporting of all Exploration Results is not practicable, representative reporting of both low and high grades and/or widths should be practiced, to avoid misleading reporting of Exploration Results.</li> </ul>	Exploration results and infill drilling results are being reported in this announcement and tabulated in the body of the text.
<b>Other substantive exploration data</b>	<ul style="list-style-type: none"> <li>Other exploration data, if meaningful and material, should be reported including (but not limited to): geological observations; geophysical survey results; geochemical survey results; bulk samples – size and method of treatment; metallurgical test results; bulk density, groundwater, geotechnical and rock characteristics; potential deleterious or contaminating substances.</li> </ul>	No geophysical and geochemical data or any additional exploration information has been reported in this release, as they are not deemed relevant to the release.
<b>Further work</b>	<ul style="list-style-type: none"> <li>The nature and scale of planned further work (e.g. tests for lateral extensions or depth extensions or large-scale step-out drilling).</li> <li>Diagrams clearly highlighting the areas of possible extensions, including the main geological interpretations and future drilling areas, provided this information is not commercially sensitive.</li> </ul>	Further drilling is planned.





## Section 3 Estimation and Reporting of Mineral Resources

CRITERIA	JORC CODE EXPLANATION	COMMENTARY
<b>Database integrity</b>	<ul style="list-style-type: none"> <li>Measures taken to ensure that data has not been corrupted by, for example, transcription or keying errors, between its initial collection and its use for Mineral Resource estimation purposes.</li> <li>Data validation procedures used.</li> </ul>	<p>Data have been compiled into a relational SQL database; the setup of this database precludes the loading of data which do not meet the required validation protocols. The data is managed using DataShed© drill hole management software using SQL database techniques. Validation checks are conducted using SQL and DataShed© relational database standards. Data has also been checked against original hard copies for 100% of the data, and where possible, loaded from original data sources.</p> <p>Resolute completed the following basic validation checks on the data supplied prior to resource estimation:</p> <p>Drill holes with overlapping sample intervals</p> <p>Sample intervals with no assay data or duplicate records</p> <p>Assay grade ranges</p> <p>Collar coordinate ranges</p> <p>Valid hole orientation data.</p> <p>There are no significant issues identified with the data.</p>
<b>Site visits</b>	<ul style="list-style-type: none"> <li>Comment on any site visits undertaken by the Competent Person and the outcome of those visits.</li> <li>If no site visits have been undertaken indicate why this is the case.</li> </ul>	<p>Mrs Susan Havlin, an employee of Optiro Pty Ltd and a Member of the Australasian Institute of Mining and Metallurgy is the Competent Person who has visited this site in February and October 2019.</p> <p>All aspects of drilling, sampling and mining are considered by the Competent Persons to be of a high industry standard.</p>
<b>Geological interpretation</b>	<ul style="list-style-type: none"> <li>Confidence in (or conversely, the uncertainty of) the geological interpretation of the mineral deposit.</li> <li>Nature of the data used and of any assumptions made.</li> <li>The effect, if any, of alternative interpretations on Mineral Resource estimation.</li> <li>The use of geology in guiding and controlling Mineral Resource estimation.</li> <li>The factors affecting continuity both of grade and geology.</li> </ul>	<p>The digital database used for the interpretation included logged intervals for the key stratigraphic zones of Tabakoroni. Detailed geological logs were available in hardcopy and digital and reviewed where necessary.</p> <p>There is a high level of confidence for the interpretation of the Tabakoroni Main Shear Zone (TMSZ) due to the close-spaced grade control drilling at surface and the confirmation of the position in the current oxide pits. There is a moderate level of confidence in the geological interpretation of the minor lodes adjacent to the TMSZ.</p> <p>Wireframes used to constrain the estimation are based on drill hole intercepts and geological boundaries. All wireframes at Tabakoroni have been constructed to a 1g/t Au cut-off grade for shape consistency.</p>



		<p>The mineralisation in the TMSZ is generally quite consistent and drill intercepts clearly define the shape of the mineralised zones with limited options for large scale alternate interpretations. The minor lodes could have alternative interpretations at depth; however, these account for only 30% of the total ounces of the deposit.</p>
<p><b>Dimensions</b></p>	<ul style="list-style-type: none"> <li><i>The extent and variability of the Mineral Resource expressed as length (along strike or otherwise), plan width, and depth below surface to the upper and lower limits of the Mineral Resource.</i></li> </ul>	<p>The mineral resource at Tabakoroni comprises five individual domains. The main zone is the TMSZ, which extends for approximately 1,800 metres along strike; the sub-vertical dipping gold mineralised zone width varies between 1.5 and 15 metres, with an average thickness of 5 metres. The Mineral Resource is limited in depth by drilling, which extends from surface to a maximum depth of approximately 350 metres vertically.</p> <p>There is a zone parallel to the TMSZ which is generally at depth and not as consistent; this is dominantly in the central part of the deposit. The northeast (NE) domain is a zone which is striking at 20° and is sub vertical in the north of the deposit. The southern lode is shallow westerly-dipping lodes in the southern portion of the deposit. The final domain is in the Namakan Deeps lode which contains shallowly west-dipping at 45° in the central portion of the deposit. The whole of the Tabakoroni deposit, including domains additional to the TMSZ, extends for 400 metres in the horizontal plane.</p>
<p><b>Estimation and modelling techniques</b></p>	<ul style="list-style-type: none"> <li><i>The nature and appropriateness of the estimation technique(s) applied and key assumptions, including treatment of extreme grade values, domaining, interpolation parameters and maximum distance of extrapolation from data points. If a computer assisted estimation method was chosen include a description of computer software and parameters used.</i></li> <li><i>The availability of check estimates, previous estimates and/or mine production records and whether the Mineral Resource estimate takes appropriate account of such data.</i></li> <li><i>The assumptions made regarding recovery of by-products.</i></li> <li><i>Estimation of deleterious elements or other non-grade variables of economic significance (e.g. sulphur for acid mine drainage characterization).</i></li> <li><i>In the case of block model interpolation, the block size in relation to the average sample spacing and the search employed.</i></li> <li><i>In the case of block model interpolation, the block size in relation to the average sample spacing and the search employed.</i></li> <li><i>Any assumptions behind modelling of selective mining units.</i></li> <li><i>Any assumptions about correlation between variables.</i></li> <li><i>Description of how the geological interpretation was used to control the resource estimates.</i></li> <li><i>Discussion of basis for using or not using grade cutting or capping.</i></li> </ul>	<p>Estimation was completed in Datamine Studio RM using an Ordinary Kriged model to estimate the gold grade. Grades were estimated into parent block of 5 mE by 10 mN by 5 mRL with sub-celling down to 1mE by 2.5 mN by 1 mRL was employed for resolution of the mineralisation boundaries as defined by wireframes. The drill spacing at Tabakoroni varies from 12.5 by 12.5 metres for grade control to between 25 and 50 metres for the exploration holes.</p> <p>Drillhole sample data was flagged using domain codes generated from three-dimensional mineralisation domains. The grade control samples and exploration samples were composited to 1 metre intervals.</p> <p>Variogram orientations were largely controlled by the strike of the mineralisation and downhole variography. Variograms for estimation purposes were determined for each domain.</p> <p>Kriging neighbourhood analysis was performed to optimise the block size, sample numbers and discretisation levels with the goal of minimising conditional bias in the gold grade estimates.</p> <p>Mineralisation domains were treated as hard boundaries in the estimation process while oxidation surfaces were treated as soft boundaries.</p> <p>Three search passes were used, with the first search pass set to the range of the variogram for each element. A minimum of 8 and a maximum of 30 samples were used. The search stayed the same for the second pass, but was increased by a factor of 3 for the third and final pass. The minimum number of samples was reduced to 6 for the second pass and 4 for the third pass.</p> <p>No deleterious elements were found in the ore.</p>



	<ul style="list-style-type: none"> <li>The process of validation, the checking process used, the comparison of model data to drill hole data, and use of reconciliation data if available.</li> </ul>	<p>No selective mining units have been assumed.</p> <p>Top cuts were applied to reduce the variability of the data and to remove the outliers.</p> <p>The estimated block model grades were visually validated against the input drillhole data and comparisons were carried out against the drillhole data and by northing and elevation slices. Global comparison between the input data and the block grades for each variable is considered acceptable (<math>\pm 10\%</math>).</p> <p>Comparison with the mine production to date was carried out and was within an acceptable limit.</p>
<b>Moisture</b>	<ul style="list-style-type: none"> <li>Whether the tonnages are estimated on a dry basis or with natural moisture, and the method of determination of the moisture content.</li> </ul>	<p>All tonnages have been estimated on a dry basis.</p>
<b>Cut-off parameters</b>	<ul style="list-style-type: none"> <li>The basis of the adopted cut-off grade(s) or quality parameters applied.</li> </ul>	<p>Mineral Resources for open pit extraction have been reported at a 1 g/t Au grade cut-off and above the current life of mine pit design. The Mineral Resources for underground mining have been reported at a 1.5 g/t Au grade cut-off and below the current life of mine pit design. The resource has been demonstrated to be amenable to underground mining.</p>
<b>Mining factors or assumptions</b>	<ul style="list-style-type: none"> <li>Assumptions made regarding possible mining methods, minimum mining dimensions and internal (or, if applicable, external) mining dilution. It is always necessary as part of the process of determining reasonable prospects for eventual economic extraction to consider potential mining methods, but the assumptions made regarding mining methods and parameters when estimating Mineral Resources may not always be rigorous. Where this is the case, this should be reported with an explanation of the basis of the mining assumptions made.</li> </ul>	<p>No mining assumptions have been made at Tabakoroni. Mining parameters, including minimum width assumptions, will be applied during the conversion to Ore Reserves.</p>
<b>Metallurgical factors or assumptions</b>	<ul style="list-style-type: none"> <li>The basis for assumptions or predictions regarding metallurgical amenability. It is always necessary as part of the process of determining reasonable prospects for eventual economic extraction to consider potential metallurgical methods, but the assumptions regarding metallurgical treatment processes and parameters made when reporting Mineral Resources may not always be rigorous. Where this is the case, this should be reported with an explanation of the basis of the metallurgical assumptions made.</li> </ul>	<p>No metallurgical factors or assumptions have been made during the resource estimation process as these will be addressed during the conversion to Ore Reserves.</p>
<b>Environmental factors or assumptions</b>	<ul style="list-style-type: none"> <li>Assumptions made regarding possible waste and process residue disposal options. It is always necessary as part of the process of determining reasonable prospects for eventual economic extraction to consider the potential environmental impacts of the</li> </ul>	<p>It is a requirement of Decree No.03-594/P-RM of 31 December 2003 of Malian law that an Environmental and Social Impact Study (Étude d'Impact Environnemental et Social – EIES) must be undertaken to update the potential environmental and social impacts of the mine's redevelopment. The EIES for the Syama Gold Mine (including Tabakoroni) was approved in November 2007 and an Environment Permit (07- 0054/MEA – SG) was</p>





	<p><i>mining and processing operation. While at this stage the determination of potential environmental impacts, particularly for a green fields project, may not always be well advanced, the status of early consideration of these potential environmental impacts should be reported. Where these aspects have not been considered this should be reported with an explanation of the environmental assumptions made.</i></p>	<p>issued by the Ministry of Environment and Sanitation on 22 November 2007. The Ministry of Environment conducts timely reviews of the Syama Gold Mine to ensure that company maintains compliance with the EIES guidelines.</p> <p>At Syama and Tabakoroni, there are three key practices for disposal of wastes and residues namely, stacking of waste rock from open pit mining; storage of tailings from mineral processes; and “tall-stack dispersion” of sulphur dioxide from the roasting of gold bearing concentrate. All waste disposal practices are in accordance with the guidelines in the EIES.</p> <p>The Environmental &amp; Social Impact Study – “Société des Mines de Syama, Syama Gold Mine, Mali”, dated 2007 indicated there was minimal potential for acid mine drainage from waste rock due to the elevated carbonate content which buffers a potential acid generation. Resolute maintains a plan for progressive rehabilitation of waste rock landforms as part of ongoing mine development and waste rock dumping.</p> <p>The landform of tailings impoundments does not have a net acid generating potential. The largest volume is flotation tailings where the sulphide minerals have already been removed from the host rock. Its mineralogy includes carbonates which further buffer any acid-formation potential from sulphides that may also be present.</p> <p>Cyanide levels in the leached-calcine tailings are typically less than 50 ppm in the weak acid dissociable form. Groundwater away from the tailings landform is intercepted by trenches and sump pumps.</p> <p>Sulphur dioxide is generated from the roasting of gold concentrate so that gold can be extracted and refined. Tall-Stack “dispersion” of the sulphur dioxide emission is monitored continuously. Prevailing weather and dissipation of the sulphur dioxide is modelled daily to predict the need to pause the roasting process to meet the air quality criteria set out in the Environmental &amp; Social Impact Study.</p>						
<p><b>Bulk density</b></p>	<ul style="list-style-type: none"> <li>• <i>Whether assumed or determined. If assumed, the basis for the assumptions. If determined, the method used, whether wet or dry, the frequency of the measurements, the nature, size and representativeness of the samples.</i></li> <li>• <i>The bulk density for bulk material must have been measured by methods that adequately account for void spaces (vugs, porosity, etc), moisture and differences between rock and alteration zones within the deposit.</i></li> <li>• <i>Discuss assumptions for bulk density estimates used in the evaluation process of the different materials.</i></li> </ul>	<p>Site personnel have completed numerous bulk density comparative estimates on HQ drill core to assess variability using the Archimedes method of dry weight versus weight in water. This method was used for 71% of the bulk density measurements. The other 29% is by unknown method.</p> <p>On the basis of the data collected the following SG estimates were applied to the model by weathering type:</p> <table data-bbox="1041 1244 1344 1388"> <tr> <td>Oxide</td> <td>2.12 t/m3</td> </tr> <tr> <td>Transitional</td> <td>2.38 t/m3</td> </tr> <tr> <td>Fresh</td> <td>2.72 t/m3</td> </tr> </table>	Oxide	2.12 t/m3	Transitional	2.38 t/m3	Fresh	2.72 t/m3
Oxide	2.12 t/m3							
Transitional	2.38 t/m3							
Fresh	2.72 t/m3							



<b>Classification</b>	<ul style="list-style-type: none"> <li>• <i>The basis for the classification of the Mineral Resources into varying confidence categories.</i></li> <li>• <i>Whether appropriate account has been taken of all relevant factors (i.e. relative confidence in tonnage/grade estimations, reliability of input data, confidence in continuity of geology and metal values, quality, quantity and distribution of the data).</i></li> <li>• <i>Whether the result appropriately reflects the Competent Person's view of the deposit.</i></li> </ul>	<p>The Measured Mineral Resource classification is based on good confidence in the geology and gold grade continuity with 12.5 m x 12.5 m spaced drillhole density in the central part of the deposit.</p> <p>The Indicated Mineral Resource classification is based on good confidence in the geology and gold grade continuity with less than 50 m x 50 m spaced drillhole density in the central part of the deposit.</p> <p>The Inferred Mineral Resource classification is applied to extensions of mineralised zones on the margins of the deposit where drill spacing is more than 50 m x 50 m and the extents of mineralisation at depth.</p> <p>The validation of the block model has confirmed satisfactory correlation of the input data to the estimated grades and reproduction of data trends.</p> <p>The Mineral Resource estimate appropriately reflects the view of the Competent Persons.</p>
<b>Audits or reviews</b>	<ul style="list-style-type: none"> <li>• <i>The results of any audits or reviews of Mineral Resource estimates.</i></li> </ul>	<p>The Mineral Resource has been audited internally and in conjunction with resource consultants at Optiro Pty Ltd as part of the routine validation process. There has been no external review of the Mineral Resource estimate.</p>
<b>Discussion of relative accuracy/confidence</b>	<ul style="list-style-type: none"> <li>• <i>Where appropriate a statement of the relative accuracy and confidence level in the Mineral Resource estimate using an approach or procedure deemed appropriate by the Competent Person. For example, the application of statistical or geostatistical procedures to quantify the relative accuracy of the resource within stated confidence limits, or, if such an approach is not deemed appropriate, a qualitative discussion of the factors that could affect the relative accuracy and confidence of the estimate.</i></li> <li>• <i>The statement should specify whether it relates to global or local estimates, and, if local, state the relevant tonnages, which should be relevant to technical and economic evaluation. Documentation should include assumptions made and the procedures used.</i></li> <li>• <i>These statements of relative accuracy and confidence of the estimate should be compared with production data, where available.</i></li> </ul>	<p>The relative accuracy of the Mineral Resource estimate is reflected in the reporting of Measured, Indicated and Inferred resource categories as defined by 2012 JORC Code guidelines.</p> <p>The estimate is considered to be relevant to an annual level of reporting of tonnage and grade.</p> <p>The estimation was compared with the production history at Tabakoroni and it is within 15% which is within the limits for the relevant classifications.</p>